

# Discover the Unknown with Ultimate Imaging and Effortless Analytics.



## **ZEISS GeminiSEM Family**

Your Field Emission SEMs for the Highest Demands in Sub-nanometer Imaging, Analytics and Sample Flexibility

[zeiss.com/geminiSEM](https://zeiss.com/geminiSEM)



Seeing beyond

# Your Field Emission SEMs for the Highest Demands in Sub-nanometer Imaging, Analytics and Sample Flexibility

- › **In Brief**
- › The Advantages
- › The Applications
- › The System
- › Technology and Details
- › Service

The name ZEISS GeminiSEM stands for effortless imaging with sub-nanometer resolution for your most demanding materials and life science projects. Combine high detection efficiency with excellent analytical performance to achieve sub-nanometer resolution below 1 kV without requiring an immersion lens. Three unique designs for the Gemini electron-optical column and a large, flexible new chamber cover all your imaging and analytical needs.

## Meet the Family:

ZEISS GeminiSEM 360 excels over the widest range of applications and sample types. Take advantage of industry-leading high resolution imaging and analytics enabled by the Gemini 1 column. As the most versatile tool, GeminiSEM 360 forms the very center of your academic, government or industrial core facility.

Choose ZEISS GeminiSEM 460 for the most challenging tasks in analytical microscopy. With its Gemini 2 column, this is your analytical platform ready and able to take on all your analytical investigations. GeminiSEM 460 gives you the efficiency and throughput you need, providing a wide current range and seamless switching between analytical and imaging conditions.

Introducing the Gemini 3 column, ZEISS GeminiSEM 560 sets the new standard for surface imaging. Smart Autopilot, its new electron optical engine, is customized for ease-of-use when imaging the most sensitive samples at the highest resolutions. GeminiSEM 560 delivers the highest resolution in the family at all working conditions and pushes the limits of immersion and monochromation-free surface imaging.

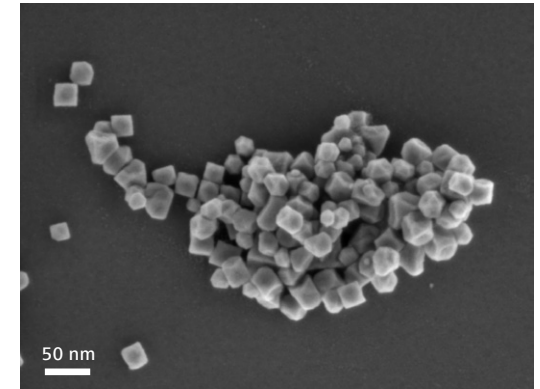

*Magnetic FeMn nanoparticles, imaged at 1 kV, GeminiSEM 560.*

# Informative Imaging. Fast Understanding.

- › In Brief
- › **The Advantages**
- › The Applications
- › The System
- › Technology and Details
- › Service

## ZEISS GeminiSEM 360: Top of the Class for Sample Flexibility

GeminiSEM 360 is the ideal instrument to build your core facility around, delivering maximum versatility for materials science, life science and industrial investigations. At the heart of the system, the industry-leading Gemini 1 design brings you the benefit of surface sensitive, high resolution images. It enables high throughput experiments, all the while providing excellent resolution at low voltage and great speed at high probe current. Perform simultaneous Inlens secondary and backscatter electron imaging and gather high resolution, surface- and compositional information, even on sensitive samples. There is no need to forgo Inlens contrast when aiming to image non-conducting samples under lower vacuum: NanoVP\* guarantees maximum versatility enabling Inlens imaging without charging.



Leverage comprehensive sample characterization with two unique Inlens detectors configured in parallel.

## Unrivalled User Experience

A core facility instrument calls for an exceptional user experience and GeminiSEM 360 delivers just that. With its generous field of view and extremely large chamber, it's easy to interrogate even very large samples. You'll enjoy seamless navigation, thanks to contextual image viewing and correlative microscopy via ZEISS ZEN Connect. Meanwhile, autofunctions and smart detectors make sure you're never more than a click away from a clear, crisp image. GeminiSEM 360 is ideal for both imaging and analytical workflows with its diametrically opposite EDS\*\* ports and coplanar EDS/EBSD\*\*\* geometry, while ZEISS Predictive Service maximizes system uptime and allows for scheduled maintenance to take place when you are ready.

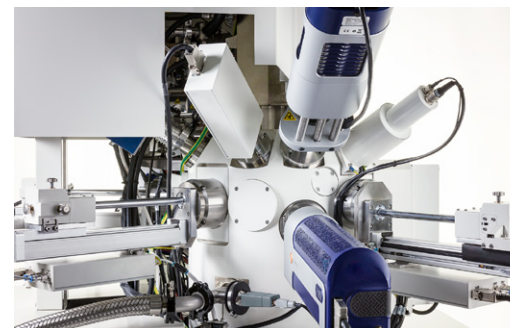

Configure your instrument tailored to your needs thanks to the versatile chamber.

## Exceptional Capability Extension

Upgradability is essential for protecting your investment. That's why GeminiSEM 360 with its highly configurable new chamber is plugged into the software ecosystem of ZEISS ZEN core. Draw on ZEN Connect to combine multimodal and multiscale data, ZEN Intellesis for advanced AI\*\*\*\*- powered segmentation, and ZEN's analytical modules for reporting and analysis of segmented data. ZEN data storage lets you manage projects centrally by connecting data from different instruments in your lab. As a member of the APEER community, you can access workflows and scripts created by other users who can help you solve challenges. A clear upgradability path means your system can be improved as new capabilities are released.

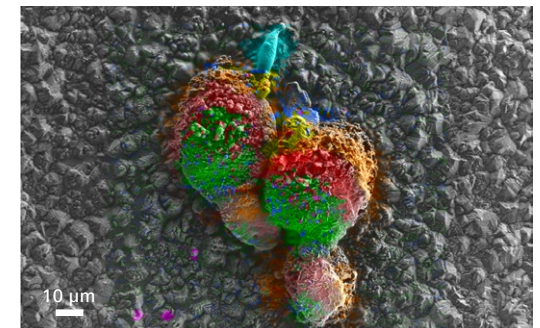

Perform multimodal experiments with ZEN Connect and understand your specimens completely.

\* Variable Pressure    \*\* energy dispersive spectroscopy    \*\*\* electron backscattered diffraction    \*\*\*\* artificial intelligence

# Efficient Analysis. Unattended Workflows.

- › In Brief
- › **The Advantages**
- › The Applications
- › The System
- › Technology and Details
- › Service

## ZEISS GeminiSEM 460 for Both High Resolution and High Current

GeminiSEM 460 is made for those most exacting analytical tasks. Enjoy the full benefits of comprehensive, efficient characterization of your specimens by using multiple detectors simultaneously. Choose from a wealth of analytical detectors to exploit the large, versatile chamber. The Gemini 2 column enables fast, high-resolution imaging and analytics by switching seamlessly from low current-low kV work to high current-high kV work, and back again—all at the click of a button. For even more demanding analytics use the new VP mode and turn up the current to obtain EBSD maps with indexing rates of 4000 patterns/s. Efficiently characterize chemical composition and crystal orientation with two diametrically opposite EDS ports and a coplanar EDS/EBSD configuration. Count on high speed, shadow-free mapping.

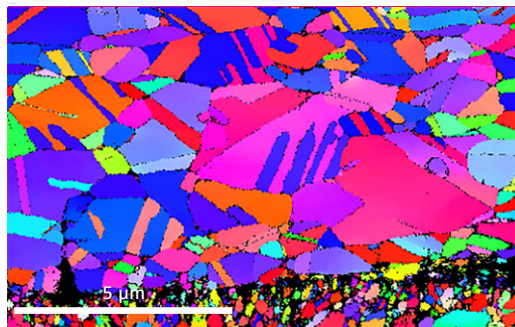

Conduct rapid analysis and achieve high current and high density simultaneously. EBSD map of a metal alloy captured in only 20 minutes, collecting signals from 185 thousand points at 20 kV and 5 nA.

\* application programming interface

\*\* Scanning Transmission Electron Microscopy

## Customize and Automate Your Workflows

With such powerful analytics at the ready, workflow automation becomes key. The Python scripting API\* from ZEISS lets you configure and create automated experiments of your own. Alternatively, you can modify experiments and customize the outcome to your own requirements. STEM\*\* tomography combines automated tilting and rotation with patented feature tracking. All aligned images are then sent to proprietary 3D reconstruction software to produce 3D tomograms with nanometer-scale resolution. When you need to test materials to their engineering limits, ZEISS puts an automated *in situ* heating and tension experimental lab at your disposal. This observes materials under heat and tension automatically while plotting stress-strain curves on the fly.



Configure your instrument tailored to your needs thanks to the versatile chamber.

## Your Pathway to Even More Possibilities

Based on the Gemini 2 design, GeminiSEM 460 allows to expand your analytical capabilities across materials and life sciences with exceptionally high, tunable current density—even at low kV. The versatile chamber lets you adapt the system with a wide variety of accessories, including analytical equipment, devices for *in situ* experiments, cryo imaging and nanoprobing. This will accommodate many configurations and upgrades at any point during the lifetime of your instrument. What's more, all GeminiSEMs are plugged into the ZEISS ZEN core ecosystem. This gives you access to ZEN Connect, ZEN Intellesis and ZEN's analytical modules providing reporting and GxP workflows to name but a few.

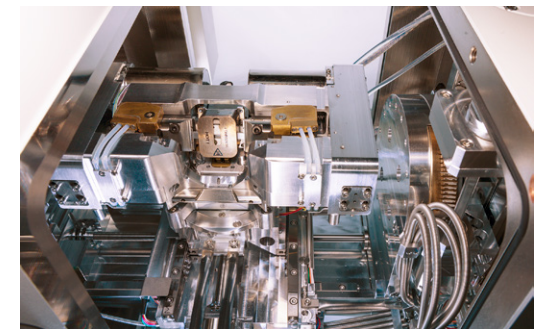

Turn your GeminiSEM 460 into an *in situ* lab.

# Imaging Below 1 kV. Expert Knowledge Integrated.

- › In Brief
- › **The Advantages**
- › The Applications
- › The System
- › Technology and Details
- › Service

## ZEISS GeminiSEM 560 – The New Standard in Surface Imaging

GeminiSEM 560 raises the bar for surface-sensitive, distortion-free, high resolution imaging. The introduction of Gemini 3 design with its Smart Autopilot electron optical engine enables magnetic field-free imaging of materials and life science samples with sub 1 kV resolution below 1 nm—without the need for sample biasing or monochromation. A completely new variable pressure mode and detection system provide superb images of non-conducting and vacuum-sensitive samples. With Gentle Airlock, it is now possible to bring vacuum-sensitive samples through the airlock in VP mode to ensure fast results and preserve sample features. A new, large chamber and dual EDS ports now produce fast, shadow-free mapping and a generous detector solid angle ensures delicate samples can be analyzed with ease.

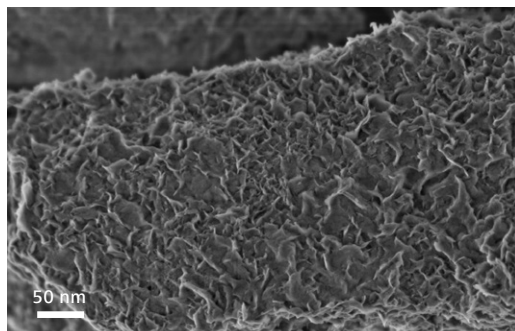

Details on the surface of a non-conducting mineral particle at low kV: GeminiSEM 560 at 800 V, Inlens SE.

## Expert Knowledge Integrated

Smart Autopilot enables the accelerated ease-of-use that is critical for imaging challenges on the edge of possibility. The system's field of view is now greatly increased, thus permitting easy, expert sample navigation. In parallel, the engine is now capable of driving the electron optics to provide magnifications from less than 1× up to 2Mx, taking care of alignment, calibration and focus along the way. This saves you time while making lengthy alignments obsolete. Smart Autopilot with new patented autofocus and its fast auto-wobble can now provide clear, crisp images within seconds. Python scripting is then able to use these features in automated workflows such as 3D STEM tomography.

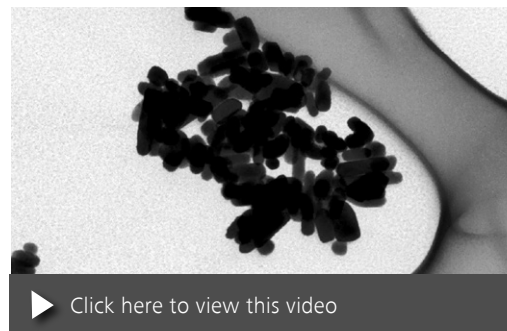

3D STEM tomography on a CeO<sub>2</sub> nanoparticle. GeminiSEM 560, aSTEM, brightfield, 30 kV.

## Experience Unique Contrast

Finding the sweet spot in your working conditions means that you've selected exactly the right combination of parameters to achieve the perfect image: the trick is finding it. Gemini column technology with its magnetic field free imaging and its new Gemini 3 column brings out new information from your sample. Magnetic contrast imaging is easy for GeminiSEM 560 with a magnetic field on the sample of less than 2 mT. Unique charging contrast at ultra-low kV gleams surface potential data which provides you with new actionable information. Perform energy spectroscopic imaging with the renowned energy-selective Inlens backscattered detector while simultaneously incorporating electron angular spectroscopic imaging, with the annular backscattered detector. Bring all of your data together with ZEN Connect to segment and report on your findings with ease.

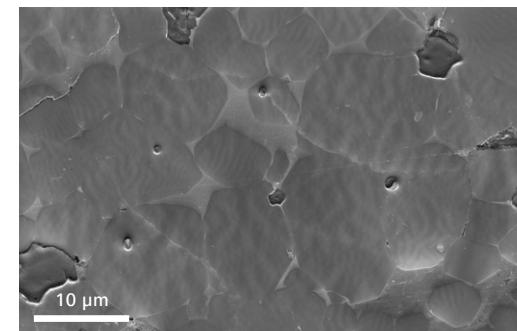

A sweet spot: Magnetic contrast on a NdFeB magnet, GeminiSEM 560, Inlens SE detector, 1 kV, WD (working distance) 5 mm, 25° stage tilt.

# Your Insight into the Technology Behind It

- › In Brief
- › **The Advantages**
- › The Applications
- › The System
- › Technology and Details
- › Service

## Exploit Gemini Optical Design

The GeminiSEM family is based on more than 25 years spent perfecting ZEISS Gemini technology. That means you can count on total and efficient detection, excellent resolution and superb ease-of-use.

The Gemini objective lens design combines electrostatic and magnetic fields to maximize optical performance while reducing field influences at the sample to a minimum. This enables excellent imaging, even on challenging samples such as magnetic materials. Inlens—the Gemini detection concept—ensures efficient signal detection by detecting secondary (SE) and backscattered (BSE) electrons in parallel. Inlens detectors are arranged on the optical axis, which reduces the need for realignment and thus minimizes time-to-image. Gemini beam booster technology guarantees small probe sizes and high signal-to-noise ratios, right down to very low accelerating voltages. It also minimizes system sensitivity to external stray fields by keeping the beam at high voltage throughout the column until its final deceleration. These advanced features—the Gemini design, Inlens detection and beam booster technology—are shared by GeminiSEM 360, GeminiSEM 460 and GeminiSEM 560.

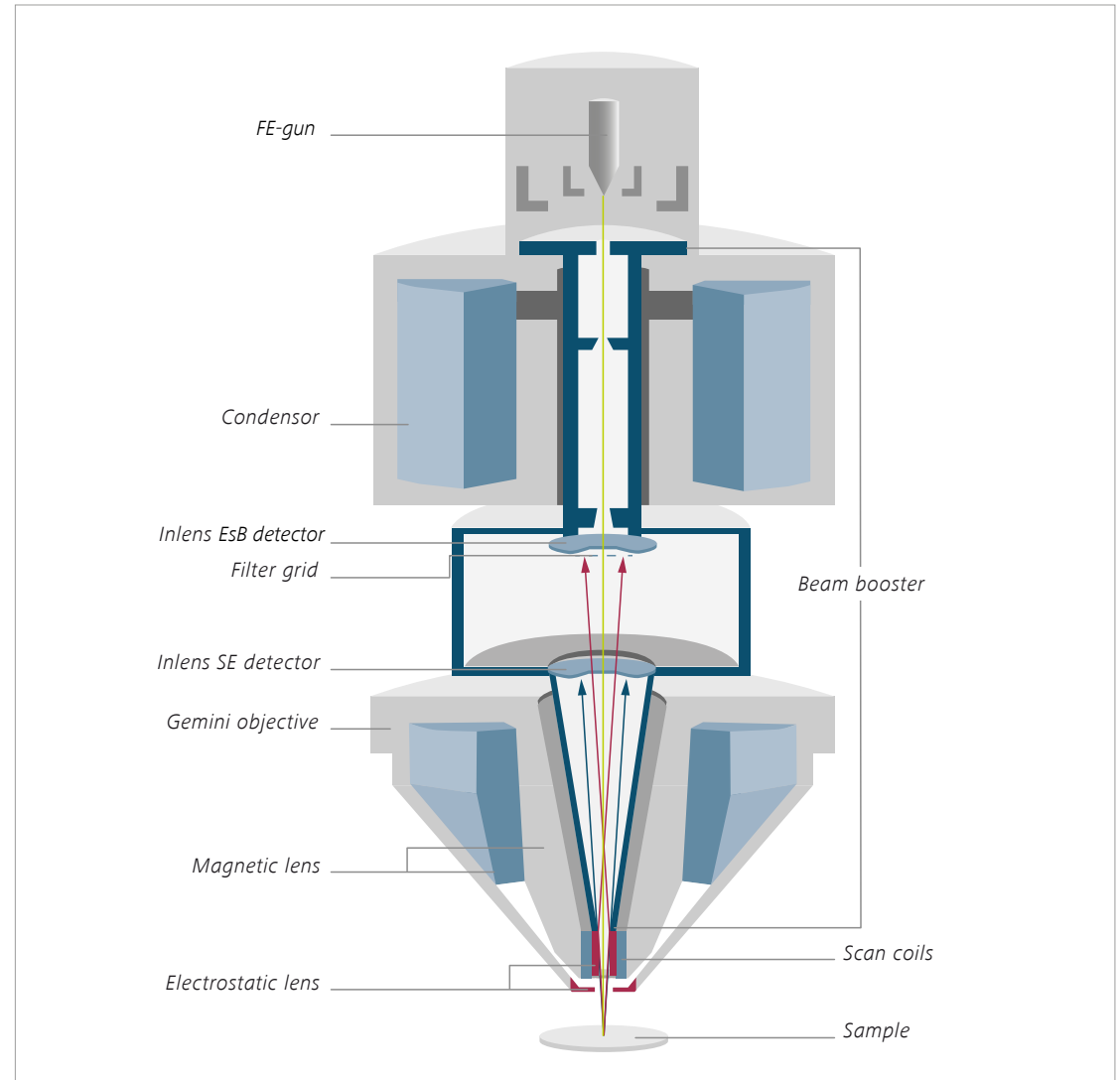

The Gemini 1 optical column consists of a beam booster, Inlens detectors and a Gemini objective.

# Your Insight into the Technology Behind It

- › In Brief
- › **The Advantages**
- › The Applications
- › The System
- › Technology and Details
- › Service

## Capitalize on Gemini 2 Optics

GeminiSEM 460 is equipped with a specialty: The main feature of its Gemini 2 optics is the double condenser arrangement which enables continuous beam current adjustment simultaneously with optimized beam spot size. This ensures the highest beam current density for high resolution imaging and analysis at both low and high beam current, independently of which beam energy you select. You can also switch seamlessly between different imaging modes or change imaging parameters. It's fast and effortless because there's no need to realign the beam after changing imaging parameters and the SEM alignment remains reliably stable.

The Gemini 2 column makes GeminiSEM 460 ideal for high resolution imaging at high beam current and for fast analytics, too. What's more, it builds on all the other advantages of previous Gemini optics. For example, Gemini optics won't expose your specimen to a magnetic field so you will achieve a distortion-free EBSD pattern and high resolution imaging over a large field of view. You can also tilt the specimen without influencing the electron-optical performance. Even magnetic samples can be imaged easily. GeminiSEM 460 offers the best overall flexibility for a whole range of different applications.

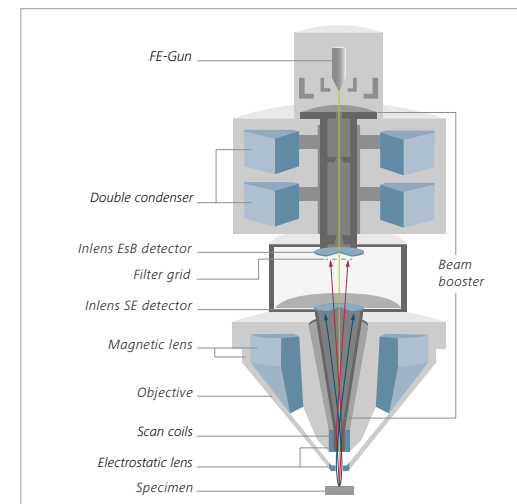

ZEISS GeminiSEM 460: Gemini 2 column with double condenser, two Inlens detectors and NanoVP or local charge compensation.

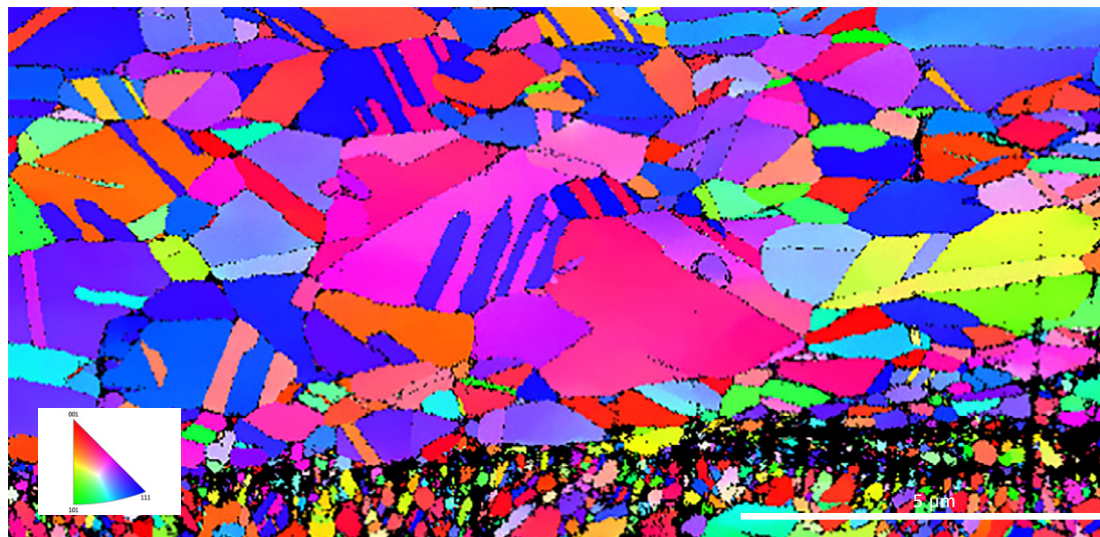

EBSD analysis of a cross-section of a Canadian coin at 20 kV and 5 nA. The total characterization of 185 thousand points takes just 20 minutes. GeminiSEM 460 lets you achieve high current and high density simultaneously.

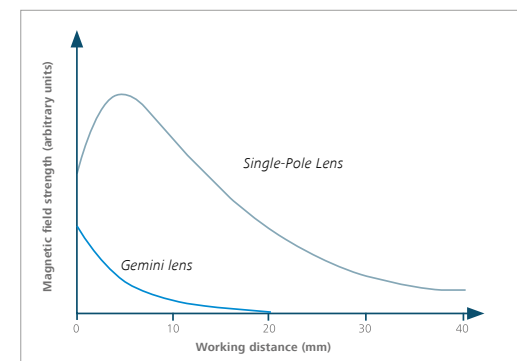

Magnetic field leakage of the Gemini lens compared to a traditional single-pole lens design. The minimum magnetic field on the sample allows highest electron beam performance on a tilted sample, enables undistorted EBSD pattern as well as high resolution imaging of magnetic materials.

# Your Insight into the Technology Behind It

- › In Brief
- › **The Advantages**
- › The Applications
- › The System
- › Technology and Details
- › Service

## Introducing the Gemini 3 Column

Designed for the most demanding tasks in surface sensitive imaging, Gemini 3 ensures maximum resolution at all working conditions from 1 kV to 30 kV. It consists of two components which work synergistically, the Nano-twin lens and Smart Autopilot, a new electron-optical engine. BSE sweet spots are also at your disposal providing unique imaging contrasts allowing you to extract the maximum information from your sample.

### Nano-twin Lens

The Nano-twin lens is a low kV optimized electromagnetic (EM) objective lens. It permits sub-nm resolution at low voltages with excellent signal detection efficiency by optimizing the geometry and the electrostatic and magnetic field distributions. Specifically, it has 3× lower lens aberrations at low kV compared to the standard Gemini lens. This results in a 3× lower magnetic field on the sample, of the order of 1 mT, and provides the ability for sub-nanometer imaging below 1 kV without immersing the sample in an EM field.

### Smart Autopilot

In combination with the Nano-twin lens, the new Smart Autopilot lets you benefit from:

- Best possible resolution at each working energy through condenser optimization of the beam convergence angle for all working conditions.

- Optimized high resolutions at ultra-low voltages enabled by the Nano-twin lens
- Seamless transition between sample navigation and high-resolution imaging realized by a new, large field of view overview mode
- Optimum image quality achieved at high speed with a new patented auto alignment function for focus and a new rapid column alignment algorithm.

Smart Autopilot optimizes electron trajectories through the column thus ensuring the highest possible resolution at each acceleration voltage. It also introduces new patented auto functions, a seamless alignment free transition across the entire magnification range from 1× to 2,000,000× and a 10× increase in the field of view allowing a full 13 cm object to be imaged in a single frame. GeminiSEM 560 maintains the largest image framestore on the market of 32k × 24k, ensuring the stitching free pixel density at this field of view is unparalleled.

### Resolution Modes

In high resolution gun mode, the reduced energy spread of the primary beam minimizes the effect of chromatic aberration to allow even smaller probe sizes.

In Tandem decel mode, a deceleration voltage is applied to the sample. Use this to further improve resolution below 1 kV and boost the detection efficiency of backscattered diode detectors.

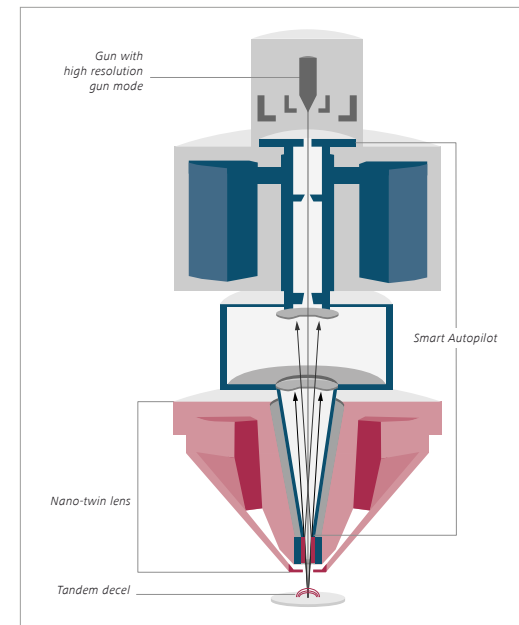

Novel optical design of the Gemini 3 column. Schematic cross-section of GeminiSEM 560. Nano-twin lens (red), Smart Autopilot (blue).

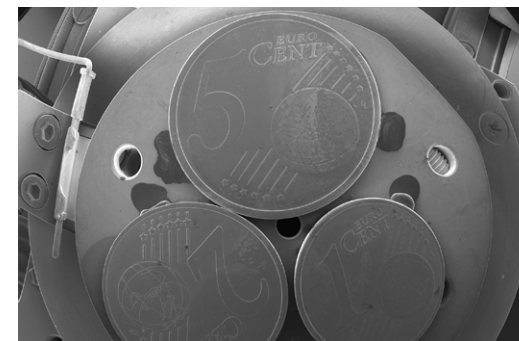

Overview mode offers an extremely large field of view and enables an easy navigation and fast relocation of ROIs. Image is taken at 5 kV using the SE2 detector.



## Your Insight into the Technology Behind It

- › In Brief
- › **The Advantages**
- › The Applications
- › The System
- › Technology and Details
- › Service

### **The Complete Detection System: Electrons Exiting the Sample are Selectively Detected according to their Take-Off Energy and Angle.**

The GeminiSEM family offers a complete detection system with a large variety of detectors. By combining Inlens EsB- (Energy selective Backscattered), Inlens SE- or aBSD- (annular Backscattered Detector) detectors, the system delivers information about the material, topography or crystallinity of your sample. The primary electron beam generates secondary electrons (SE) and backscattered electrons (BSE). The SEs escape directly from the topmost nanometers of your sample with energy of less than 50 eV and show the topography of the surface. As a result of the unique beam booster concept, these SEs are accelerated back into the column and the Gemini objective lens directs them to the annular Inlens SE detector. Depending on the surface condition of your sample, GeminiSEMs detect the SEs over a wide angular range.

BSEs are generated below the surface and provide highly specific information about the material composition of your sample. BSEs appear conically at a 15 degree angle to the primary electron beam and are attracted by the beam booster of the Gemini column and directed into the column. Because of the different energies of SEs and BSEs, they follow different trajectories within the beam booster. Most of the BSEs can pass the Inlens SE detector and are collected by the EsB detector. Additionally, the Inlens EsB detector enables an energy selection of the BSEs. If the take off angle is larger than 15 degrees, the BSEs cannot make their way into the column, but can be stopped and detected by either AsB (Angular selective Backscatter) or the retractable aBSD detector. The aBSD detector delivers compositional, topographical and 3D surface information. Both chamber backscattered (BSD) and transmitted electron detectors have been improved for high efficiency at low beam voltages and ultra-fast imaging. The annular STEM (aSTEM) detector brings maximum flexibility so you can exploit all contrast mechanisms in transmission imaging, even in parallel.

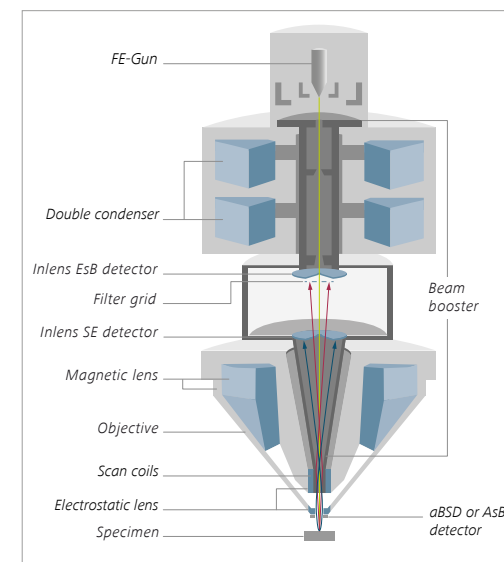

*ZEISS GeminiSEM 460 with Gemini 2 optical column including beam booster, Inlens detectors and Gemini objective lens. The double condenser is unique to the Gemini 2 optics. Two Inlens detectors can be configured for all models of the GeminiSEM Family.*

# Your Insight into the Technology Behind It

- › In Brief
- › **The Advantages**
- › The Applications
- › The System
- › Technology and Details
- › Service

## Get to Know GeminiSEM's Detection System

Characterize all of your samples comprehensively with the latest detector technology.

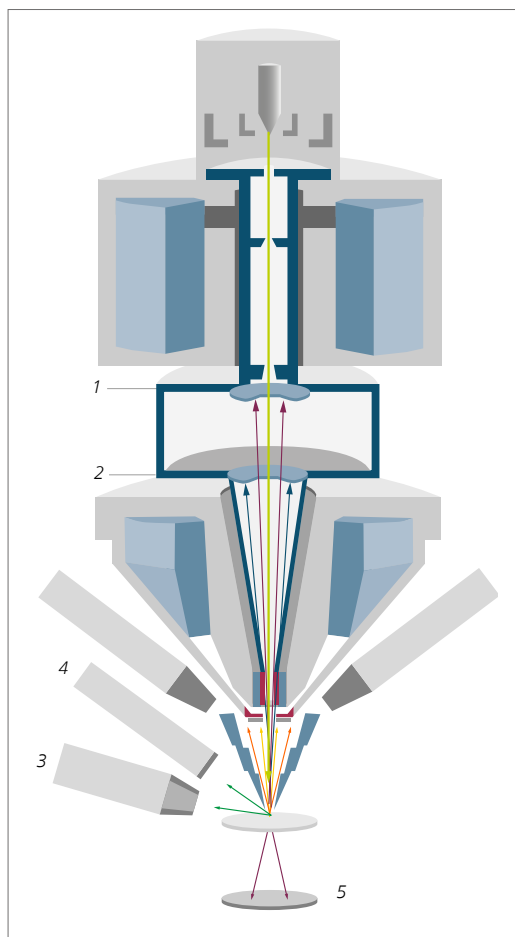

Schematic cross-section of Gemini optical column with detectors.

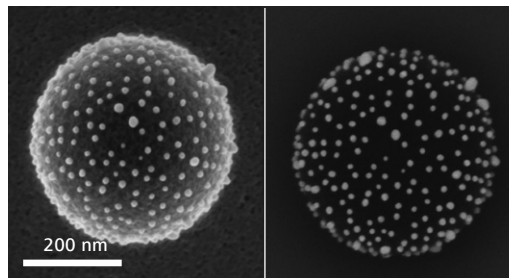

### 1 Inlens BsE Detector and 2 Inlens SE Detector

*Inlens SE: High resolution topographical contrast at low kV by the in-column SE detector (left).  
Inlens BsE: Highly sensitive material contrast at low kV by the in-column back scattered electron detector (right).*

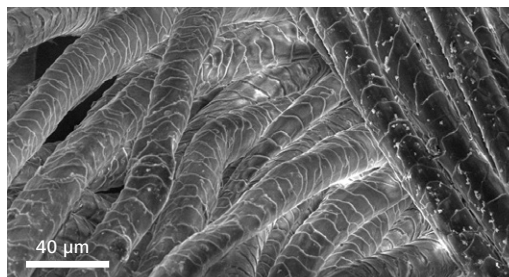

### 4 VPSE Detector

*Topographical contrast in VP mode through the chamber mounted VPSE detector.*

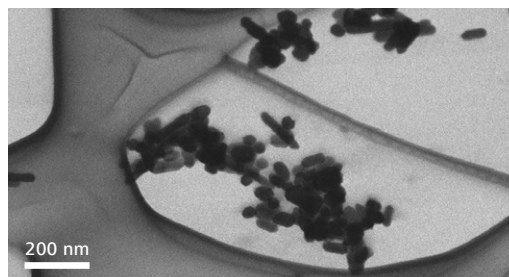

### 5 aSTEM Detector

*Annular STEM detector for producing high resolution transmission images. Provides brightfield, darkfield and high-angle annular darkfield (HAADF) modes, e.g. of thin films or biological sections.*

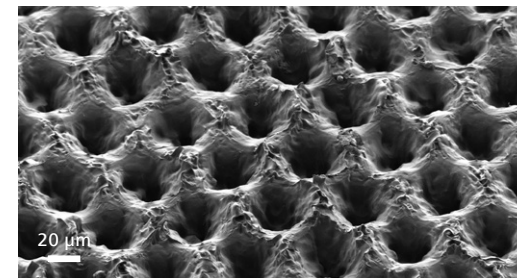

### 3 SE2 Detector

*Topographical contrast in high vacuum mode at large working distance, and at high kV through the chamber mounted SE detector.*

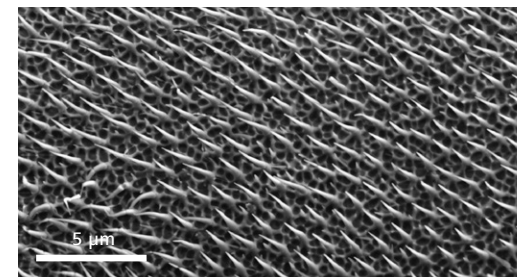

### 4 C2D

*Improved sensitivity for crisp and clear images in VP mode, even at higher pressure and lower voltages by Cascade Current Detector (C2D), which creates an ionization cascade and measures the resulting current*

# Your Insight into the Technology Behind It

- › In Brief
- › **The Advantages**
- › The Applications
- › The System
- › Technology and Details
- › Service

## Use Flexible Detection for Clear Images

Characterize all of your samples with the latest detector technology.

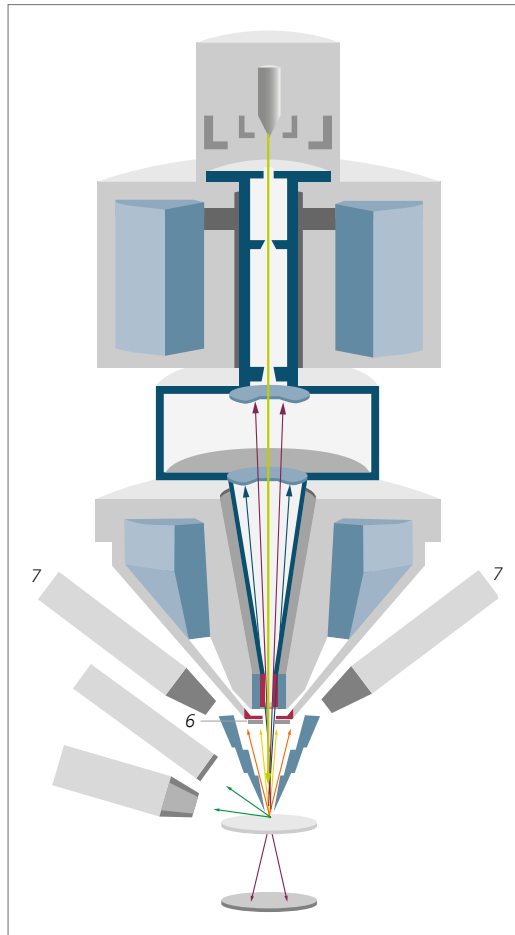

Schematic cross-section of Gemini optical column with detectors.

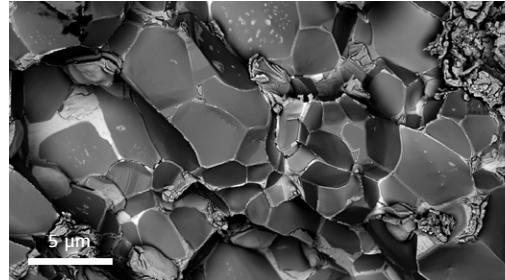

**6 aBSD Detector**  
Highly sensitive compositional, topographical and 3D surface information by the annular back scattered electron detector.

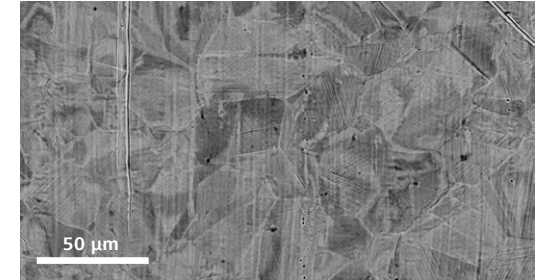

**6 AsB Detector**  
Angular selective BSE detector for crystallographic and channeling contrast imaging of metals and minerals.

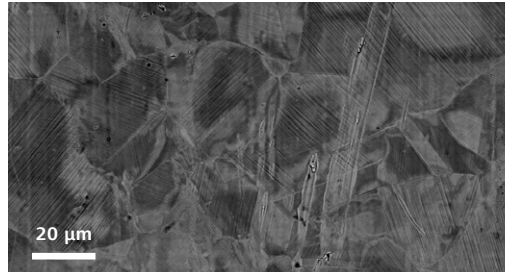

**6 YAG Detector**  
High definition BSE detector for excellent low kV compositional imaging of all samples in all vacuum modes.

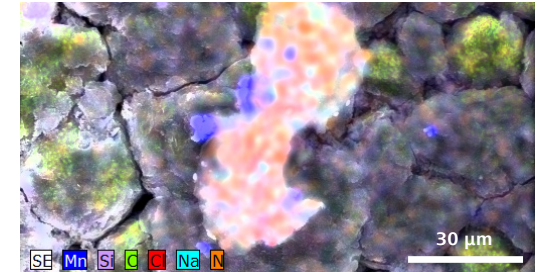

**7 Advanced EDS Detection**  
Advanced EDS analysis geometry of 8.5 mm working distance and 35° take-off angle for delivering data at twice the speed or half the probe current, Sample: courtesy of University of Leicester, United Kingdom.

# Expand Your Possibilities with ZEISS ZEN core

- › In Brief
- › **The Advantages**
- › The Applications
- › The System
- › Technology and Details
- › Service

## A Spotlight on Multi-modal Microscopy with ZEN Connect

Organize and align your image data in the correlative workspace of ZEN Connect. ZEN Connect is an open platform and accepts ZEISS or third party data: all image data can be imported and shown in context. As long as your external images adhere to the well-established Bio-Formats standard, ZEN Connect will keep their metadata. You can even import non-image data (e.g. descriptions, notes, reports, spectra ...) and attach them to your images with virtual pins at the corresponding position in the workspace.

Create sessions and accumulate data in your project regardless of which microscope you currently use. You'll locate your regions of interest immediately by using a light microscopy overview image for navigation in the FE-SEM. Align a session just once and all images acquired in this session will automatically be placed at their correct position in the workspace.

Advanced export functionalities come with many benefits. Export overlay images as a burned-in combination or as multichannel images with all layers in dedicated channels. Specify the pixel size for export, then zoom and pan within the correlative workspace. For an interactive experience, it's easy to export your data as a movie.



Multi-modal investigation of an electronics part, connecting images from light microscopy, SEM and analytical data in EDS maps. View of the GUI of the correlative workspace of a ZEN Connect project with aligned data. Sample: Electronics part, embedded and mechanically polished cross-section. Sample: courtesy of Aalen University, Materials Research Institute, Aalen, Germany.

# Expand Your Possibilities with ZEISS ZEN core

- › In Brief
- › **The Advantages**
- › The Applications
- › The System
- › Technology and Details
- › Service

## A Spotlight on 2D Correlative Microscopy with ZEN Connect

Extend ZEN Connect with this easy-to-use software module. The module focuses on 2D applications and creates a productive and automated correlative workflow that overlays data from your light microscope and scanning electron microscope. By combining the optical contrast methods of the light microscope with the analytical methods of the electron microscope, you will discover new information about the function, structure and chemical composition of your sample.

### How it Works:

Using a special specimen holder with three fiducial markers, a coordinate system is generated within seconds. Use the light microscope to define interesting regions in your sample. Then relocate the defined regions in the electron microscope where you will be able to improve the resolution by several orders of magnitude. Now you can continue examining the sample more extensively. Finally, use ZEN Connect to correlate and export the images taken by the different microscopical techniques.

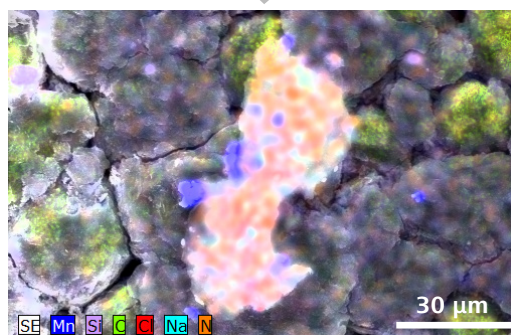
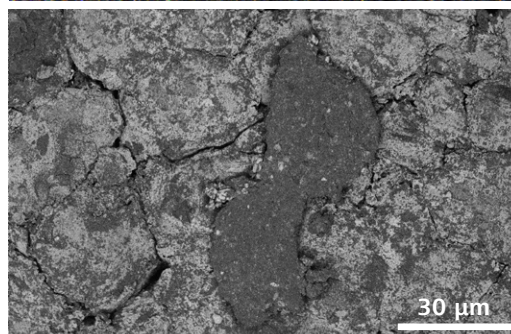

Lithium ion battery. Top: light microscope image. Center: SEM image. Bottom: Overlay of both, combined with EDS analysis.

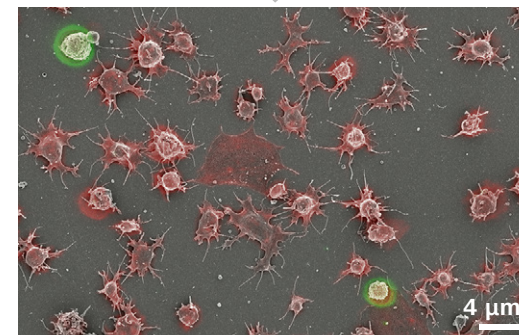
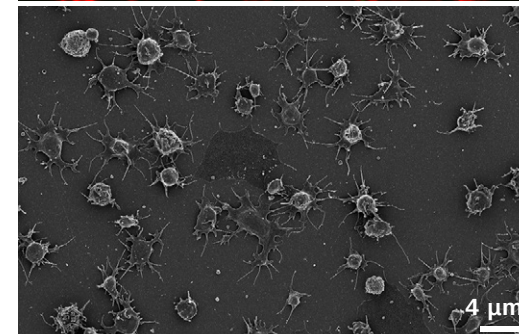
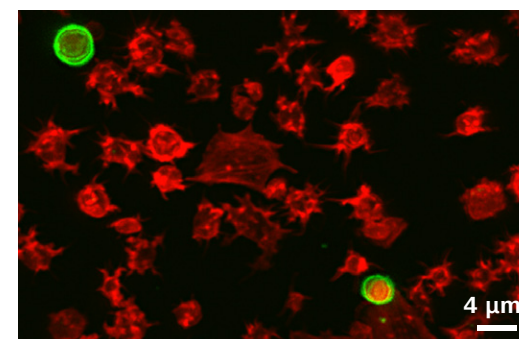

Platelets stained with AF647 (cellular platelet protein, false color: green) and AF555 – Phalloidin (false color: red). Top: Laser Scanning Microscopy fluorescence image. Center: SEM image. Bottom: Overlay. Courtesy: of D. Woulfe & J. Caplan, University of Delaware, USA.

# Expand Your Possibilities with ZEISS ZEN core

- › In Brief
- › **The Advantages**
- › The Applications
- › The System
- › Technology and Details
- › Service

## ZEN Automated Imaging

Make your SEM imaging more reliable and reproducible by leveraging the workspace from ZEN Connect. Set up regions for automated SEM mosaic acquisition, using one of the predefined yet adjustable imaging protocols. Or create your own, tailored to your needs. Acquisition regions can have rectangular, round or freehand shapes, distributed all across the sample holder. Queue them up in a process list and have them acquired at your chosen pixel resolution automatically—for instance, overnight. Also use the same imaging protocols for single frame acquisition, even in Job Mode, and guide your operators with consistent SEM imaging workflows.



Create acquisition regions for SEM mosaics within the workspace from ZEN Connect and have them automatically acquired.

## ZEN Intellesis

Once you've acquired your SEM images, analysis may well be the next step in your workflow. ZEN Intellesis is the logical starting point for in-depth evaluation and measurement, using machine learning to segment your images. You can import your own pre-trained neural network or train a model based on a subset of your image data by labeling corresponding image areas with a mouse. Once the model is trained, ZEN Intellesis segments the full dataset and provides you with class information for every pixel. You can even combine datasets in ZEN Connect and use stacks as individual training layers. Once segmented, ZEN's evaluation modules enable you to automatically create reports and perform measurements to industrial standards.

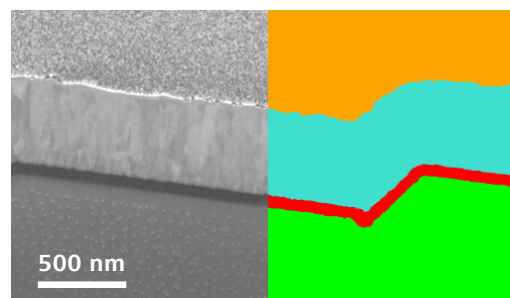

Overlay of FIB cross-section SE image (left) of CIGS solar cell layers with ZEN Intellesis segmentation (right) result. Sample: courtesy of T. M. Friedlmeier, ZSW Stuttgart, Germany.

## ZEN Data Storage

When organizing your imaging work, being able to separate acquisition and post-acquisition analysis by storing your data on a centralized server is a great help. ZEN Data Storage connects with all your light- and electron microscopes operated by ZEN, and even with third party devices. Upload images and ZEN Connect projects to this database along with presets, workflows, protocols, reports and any other data related to your samples. Access your data from any connected workstation to facilitate offline image analysis and free up instrument time. Take advantage of built-in centralized user management and share data between systems, labs and locations. Using the ZEN Data Explorer App you can even access and review data from your mobile device.

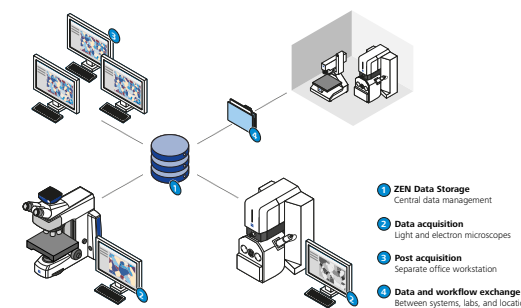

ZEN Data Storage stores your data in a central database so that it is accessible from any microscope or analysis workstation.

# Expand Your Possibilities with ZEISS Atlas 5

- › In Brief
- › **The Advantages**
- › The Applications
- › The System
- › Technology and Details
- › Service

## ZEISS Atlas 5 –

### Master Your Multiscale Challenge

Atlas 5 makes your life easier by creating comprehensive multiscale, multimodal images with a sample-centric correlative environment. This powerful yet intuitive hardware and software package extends the capacity of your GeminiSEM.

Use its efficient navigation and correlation of images from any source. Take full advantage of high throughput and automated large area imaging with protocols. Unique workflows will help you gain a deeper understanding of your sample. Benefit e.g. from Automated STEM imaging or Array tomography. Its modular structure lets you tailor Atlas 5 to your everyday needs in materials or life sciences research. Extend your possibilities even further with modules—e.g. for nanopatterning with the NPVE module or for reporting or sharing results with the module Enhanced Browser-based Viewer Export.



Easy-to-use, workflow-oriented GUI for automated imaging.

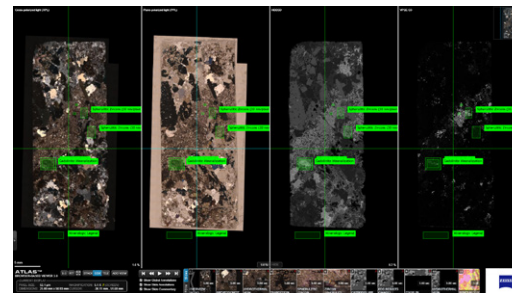

Multi-modal experiment including light and electron microscopy on a polished petrographic thin section, visualized by Enhanced Browser-based Viewer Export. Sample: Peralkaline granite from Northern Quebec. Sample and dataset: courtesy of A. Gysi, D. Schumann, Fibics Incorporated, Ottawa, Canada.

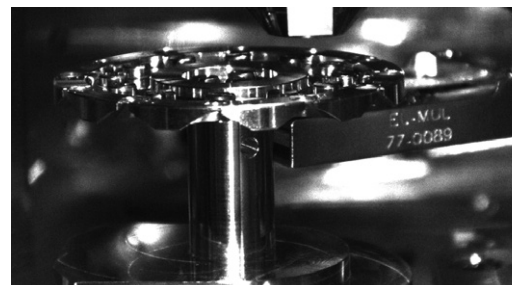

Mount your STEM sample holder for 12 TEM grids into the SEM. Place your STEM detector beneath one of the TEM grids.



Light microscope and SEM images of an integrated circuit are merged in the correlative workspace of Atlas 5.

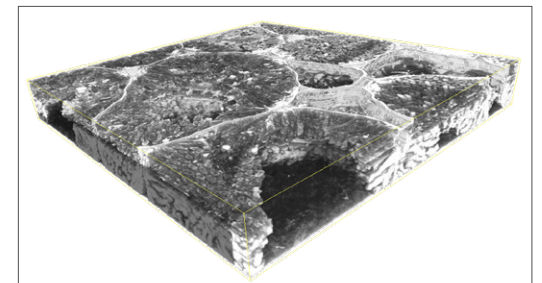

Medicago root nodules. SEM images by Atlas 5 Array Tomography. Sample: courtesy of J. Sherrier, J. Caplan & S. Modla, University of Delaware, USA.



Start your new STEM project and easily navigate between samples.

# Expand Your Possibilities with a Cryo Solution for Materials

- › In Brief
- › **The Advantages**
- › The Applications
- › The System
- › Technology and Details
- › Service

## Cryo Solutions for Materials Research

Traditionally, electron microscopy at cryogenic temperatures has been linked to life science applications. However, there are also many use-cases of cryo in materials research.

Use cryo during SEM analysis to stabilize beam-sensitive materials such as chalcogenides, polymers and some III-V semiconductors. You won't need a full-blown cryo system for such applications. The sample can be transferred into the microscope at room temperature, using any of the standard airlocks from ZEISS.

A cost-optimized cryo solution will add a new level of versatility to your ZEISS FE-SEM with artefact-free imaging of beam-sensitive samples.

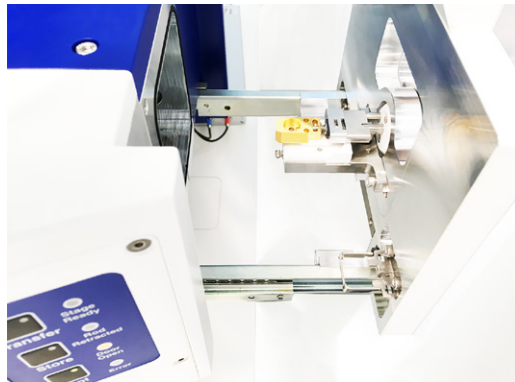

The cryo sample holder is transferred at room temperature onto the cryo stage through the standard airlock from ZEISS.

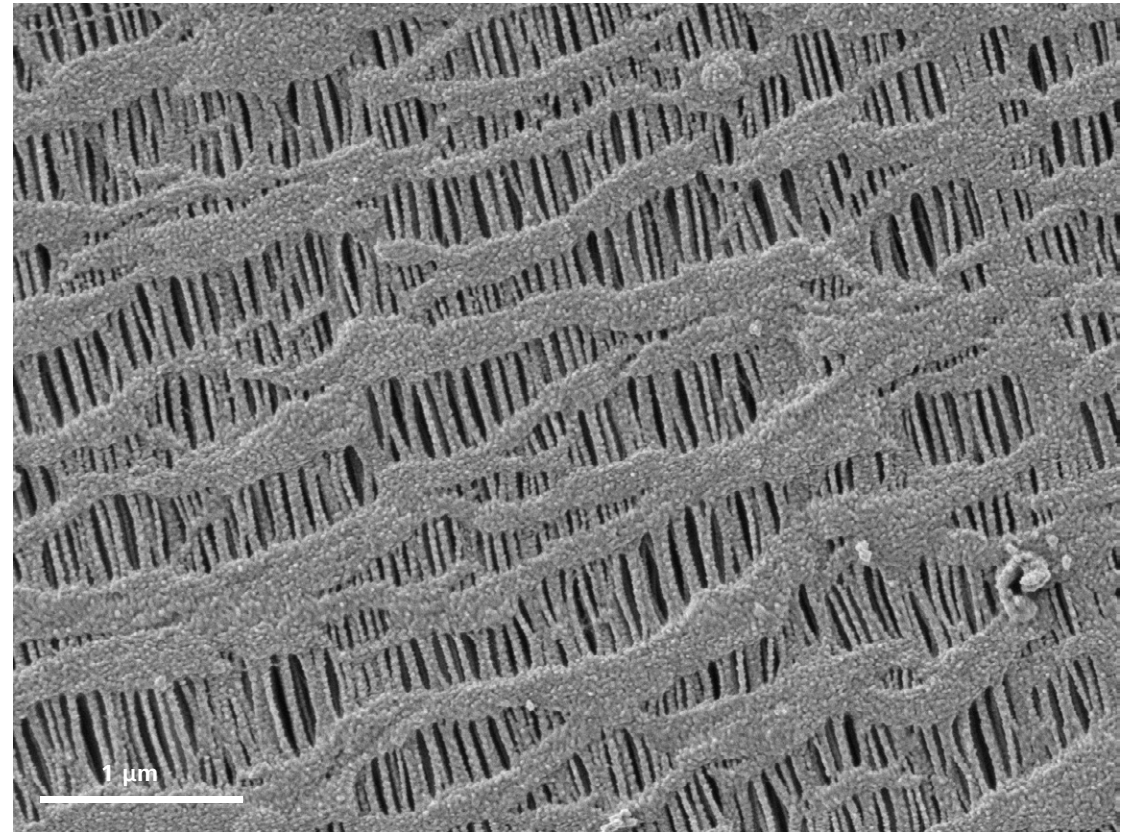

Polypropylene separator foil imaged at cryogenic temperature,  $-160^{\circ}\text{C}$ . At room temperature the sample is very sensitive to electron beam irradiation so its structure is heavily modified by the imaging beam. At low temperatures, the structure is much more robust and can be observed for several minutes at a time without damage.



# Expand Your Possibilities with 3D STEM Tomography

- › In Brief
- › **The Advantages**
- › The Applications
- › The System
- › Technology and Details
- › Service

## 3D STEM Tomography

Automated STEM tomography on an FE-SEM is now put at your disposal. A script for automated acquisition of a STEM tilt series uses the API and performs compucentric rotation and tilt stage movements as well as autofocus and image acquisition. Feature tracking compensates for shifts throughout the entire tilt series and keeps the drift between two images to a minimum of around 50 nm. The STEM sample holder allows tilt to 60° and 180° rotation, and the aSTEM detector covers all requirements. 3D reconstruction software then takes this output and renders a 3D model of your sample.



*ZnO nanoparticles on a carbon film. STEM tilt series, annular darkfield STEM images are shown as one example of four signals collected in total simultaneously with the aSTEM detector using the special sample holder for STEM tomography.*

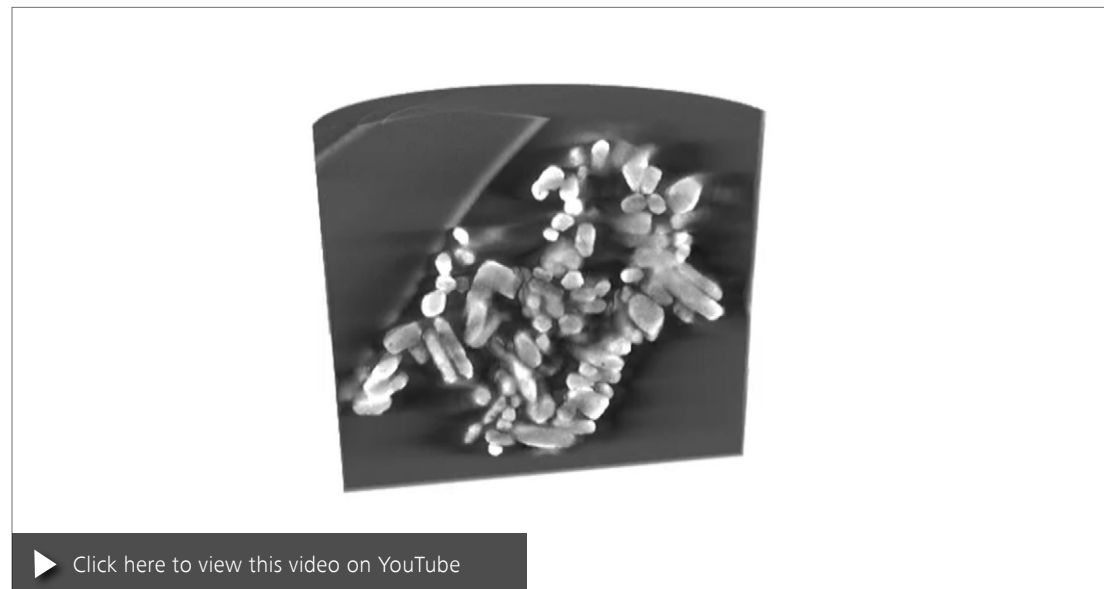

*ZnO nanoparticles on carbon film, back-projection reconstruction showing the 3D morphology of the nanoparticles.*

# ZEISS GeminiSEM at Work: Materials Sciences

- › In Brief
- › The Advantages
- › **The Applications**
- › The System
- › Technology and Details
- › Service

## Nanoscience & Nanomaterials

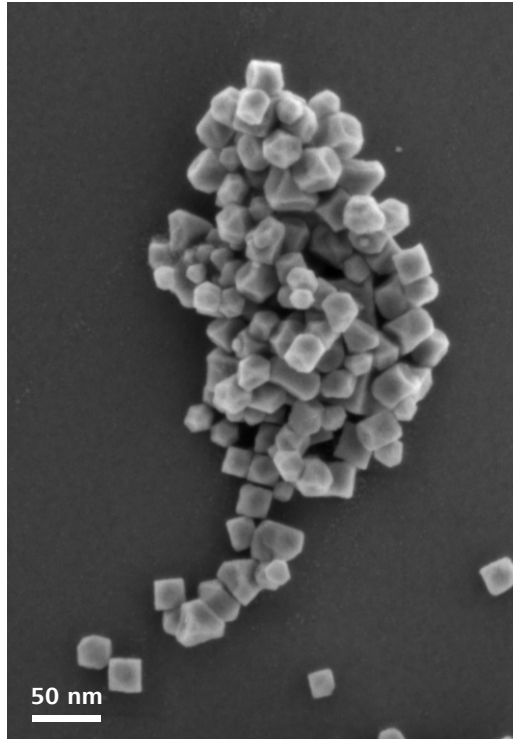

*Magnetic FeMn nanoparticles, imaged at 1 kV, Inlens SE detector, GeminiSEM 560.*

The groundwork for tomorrow's innovations is already being laid by today's research in nanoscience and nanomaterials. Scientists will need to understand and control structures at the nanoscale to advance existing technology, all the while being driven by the prospect of developing novel materials that can lead to entirely new products and industrial processes. Continuous progress in nanotechnology is a prerequisite for better electronic and communication equipment—devices with more processing power that are cheaper to manufacture and cheaper to run. Some nanomaterial-based catalysts promote the efficient use of energy and resources while other nanomaterials are employed in water and air treatment. Nanosensors make our environment safer and, in medicine, nanoscience improves diagnostics and patient care. In all these ways ZEISS FE-SEMs are indispensable tools for leveraging this vital understanding at the nanometer scale and for advancing nanoscience and nanomaterials research.

## Typical Tasks and Applications

- Visualizing structure, integrity and failure in nanoelectronic and photonic devices
- Imaging sensitive specimens such as 2D materials while avoiding major beam damage, charging effects or image distortions
- Studying nanomagnetism and nanomechanics at high resolution, characterizing the material's surface topography and analyzing its elemental composition
- Creating and evaluating the quality of devices for nanofluidic experiments

## How You Benefit from ZEISS GeminiSEM

- High-resolution imaging that unveils the nano structure of materials and devices
- Electron beam lithography for device prototyping
- Microscopy analyses bridging multiple length scales
- Different imaging and analytical modalities combined to maximize information from your sample

# ZEISS GeminiSEM at Work: Materials Sciences

- › In Brief
- › The Advantages
- › **The Applications**
- › The System
- › Technology and Details
- › Service

## Nanoscience & Nanomaterials

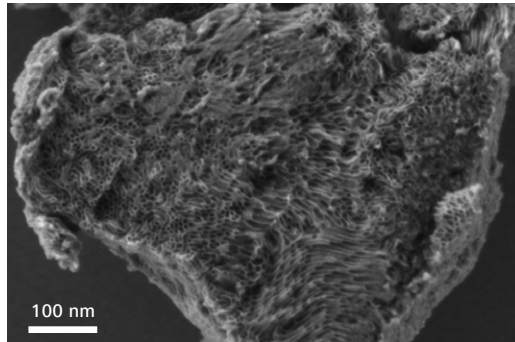

Mesoporous silica, imaged at 500 V, Inlens SE detector.

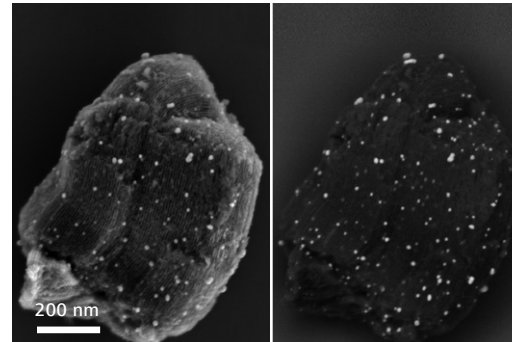

Catalyst: Silver nanoparticles embedded in Zeolite, Inlens SE detector (left) and EsB detector (right). EHT 1.5 kV. Sample: courtesy of G. Weinberg, Fritz-Haber-Institute of the Max-Planck Society, Germany.

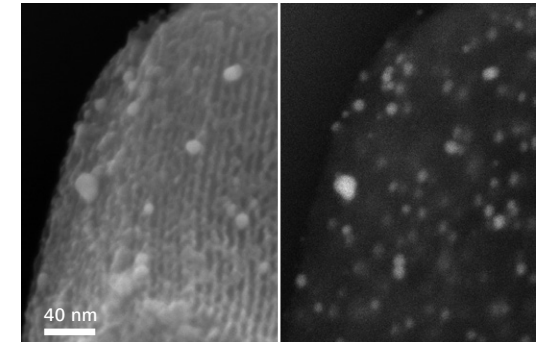

Catalysts: Zeolite with Ag nanoparticles, imaged at 5 kV using dual channel Inlens SE detector (left) and EsB detector (right). Sample: courtesy of G. Weinberg, Fritz Haber Institute of the Max Planck Society, Germany.

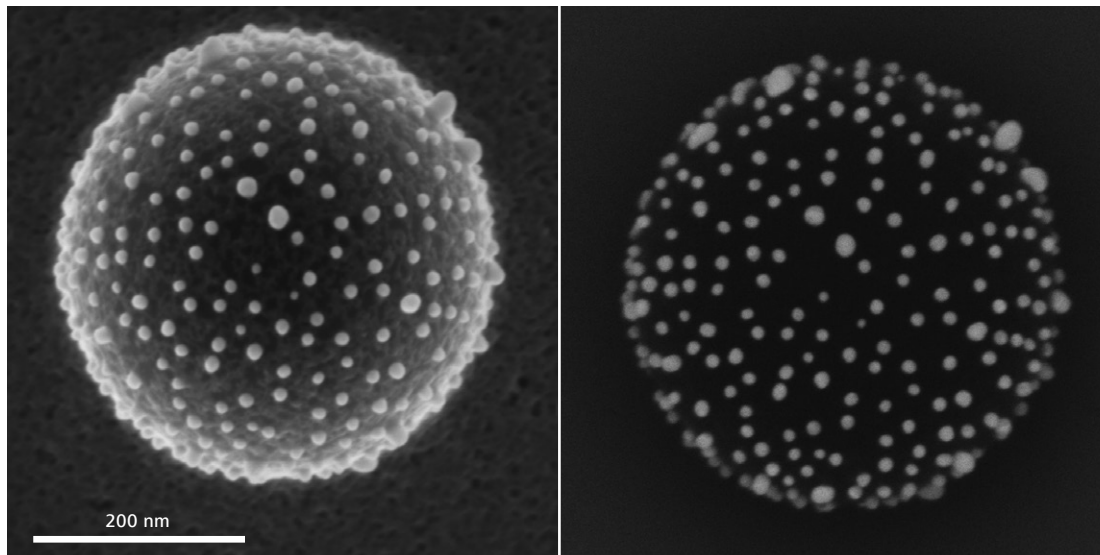

Precursor material for functional surface, gold nanoparticles on polystyrol sphere, imaged at 3 kV. Left: Inlens SE image, surface topography. Right: Inlens EsB image, material contrast. Sample: courtesy of N. Vogel, University of Erlangen-Nuremberg, Germany.

# ZEISS GeminiSEM at Work: Materials Sciences

- › In Brief
- › The Advantages
- › **The Applications**
- › The System
- › Technology and Details
- › Service

## Nanoscience & Nanomaterials

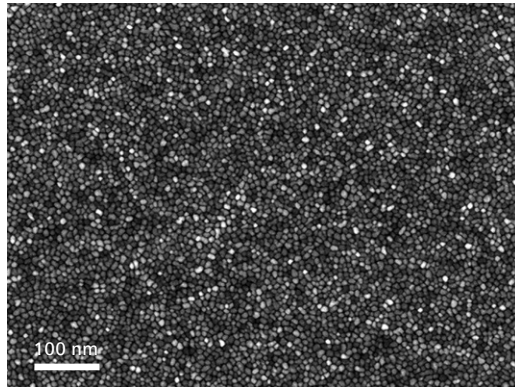

Magnetic grains of a data storage medium. The different gray levels of the nano-scaled grains are the effect of channeling contrast that provides information on how the nanocrystals are differently oriented. Image taken with the aBSD detector at 20 kV in GeminiSEM 460.

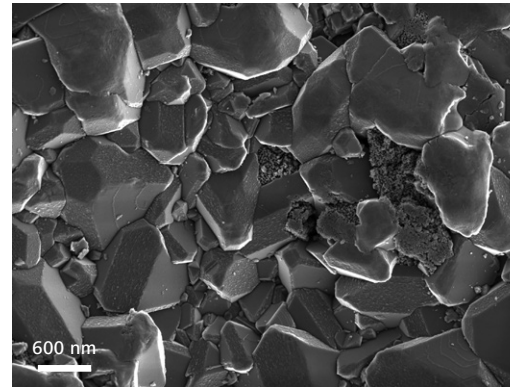

$\text{Fe}_2\text{O}_3/\text{ZrO}_2$ , a composite nanomaterial that is used as a catalyst for chemical-looping hydrogen production processes. It can be characterized comprehensively by combining the information from images of the Inlens SE (left) and the Inlens EsB detector (right). Images taken with GeminiSEM 460 at 2 kV.

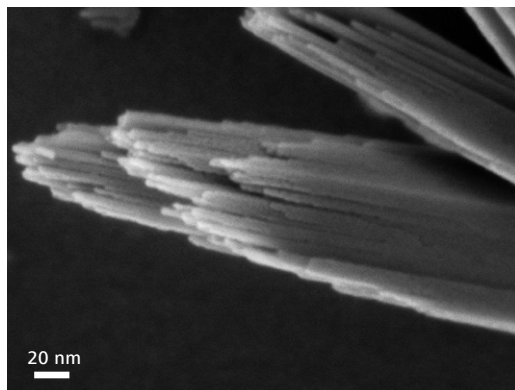
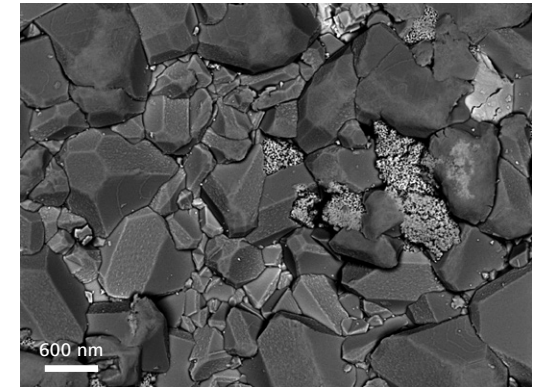

Nanometer spaced  $\text{FeO(OH)}$  crystals, at 1 kV. Sample: courtesy of: L. Maniquet, INP Grenoble, France.

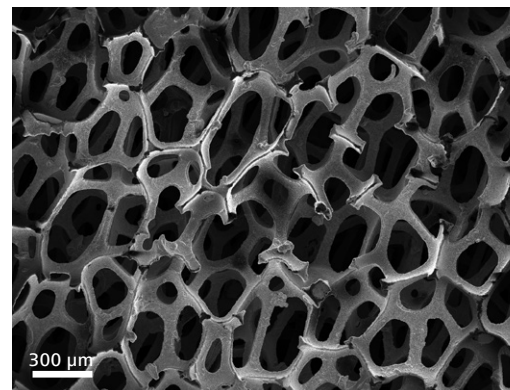

Metal foams like this open cell nickel foam are widely used as cathode substrate in batteries or super-capacitors. This highly topographic foam is characterized with large depth of focus (DOF) using the Inlens SE detector GeminiSEM 460 at 8 kV. Note the large undistorted FOV.

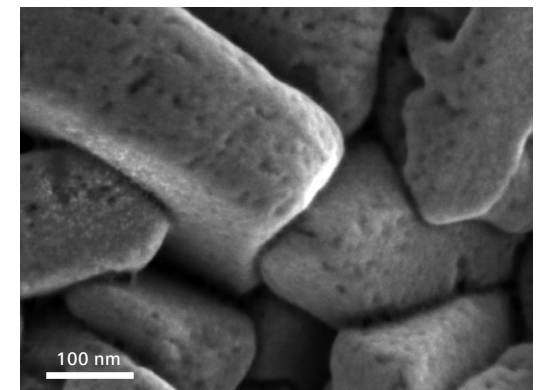

Copper nanocrystals imaged using the Tandem decel option applying a sample bias of -3 kV. This enhances contrast and resolution.

# ZEISS GeminiSEM at Work: Materials Sciences

- › In Brief
- › The Advantages
- › **The Applications**
- › The System
- › Technology and Details
- › Service

## Nanoscience & Nanomaterials

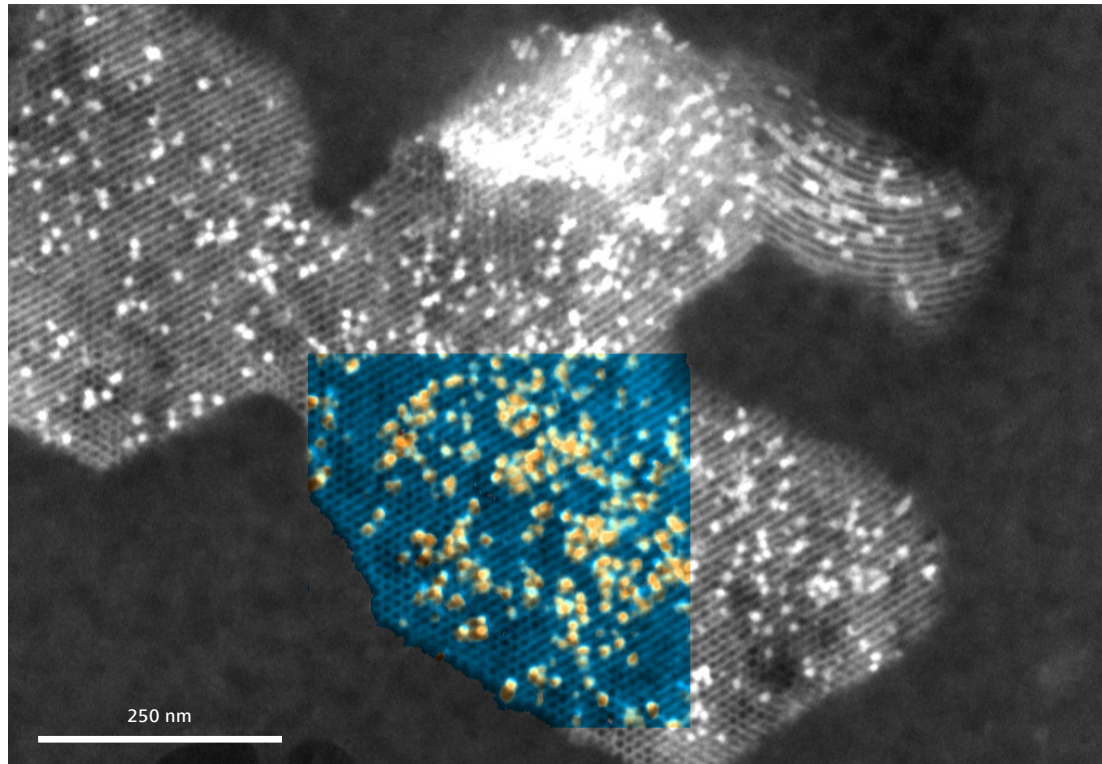

Silica-supported cobalt catalyst is characterized by means of high-resolution imaging and EDS analysis at 25 kV using GeminiSEM 460. Cobalt nanoparticles of about 10 nm in size embedded in mesoporous silica are shown in high resolution, imaged with aSTEM detector overlaid with the EDS map. In the Fischer-Tropsch synthesis, the 10 nm supported Co catalyst proved to be the most active and selective catalyst for hydrocarbon formation.

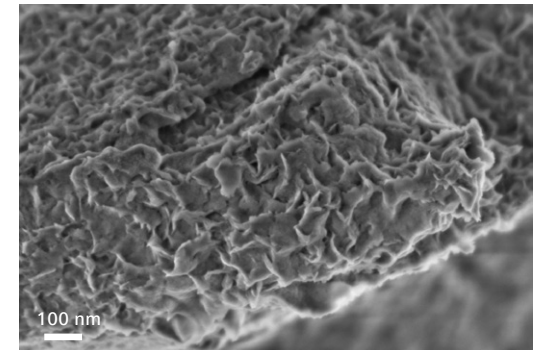

To characterize nanometer-scaled particles of montmorillonite, take advantage of ultra low kV imaging performed with the InLens SE detector on GeminiSEM 560 at 800 V.

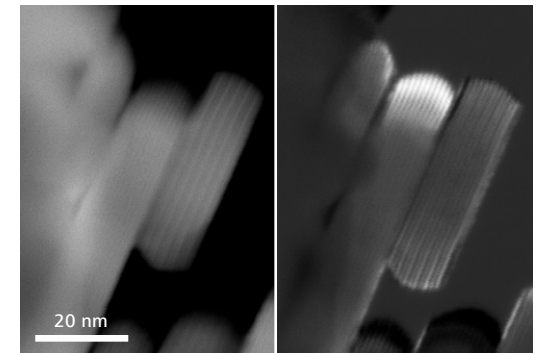

$\text{BaFe}_{12}\text{O}_{19}$  nanoparticle with 1.1 nm (002) lattice spacing imaged with the annular STEM, at 22 kV with GeminiSEM 560: (left) oriented darkfield and (right) high angle annular darkfield images show mass thickness contrast between Ba and Fe with lattice resolution. Sample: courtesy of H. Romanus, TU Ilmenau, Germany.

# ZEISS GeminiSEM at Work: Materials Sciences

- › In Brief
- › The Advantages
- › **The Applications**
- › The System
- › Technology and Details
- › Service

## Nanoscience & Nanomaterials

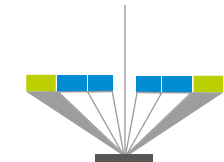
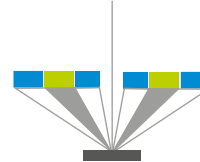
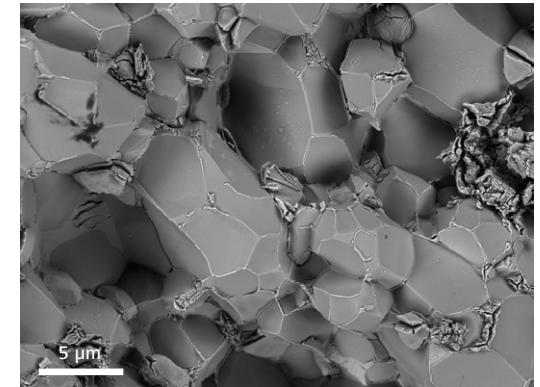
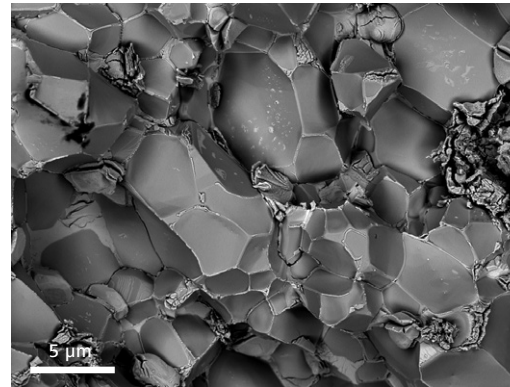
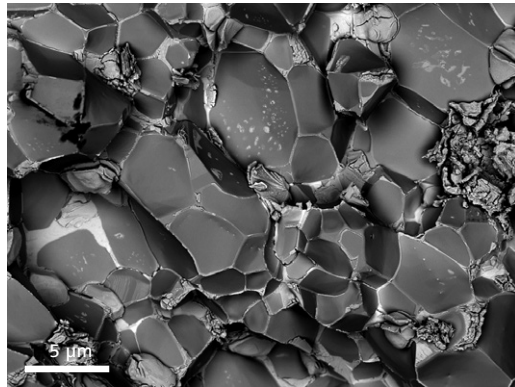

Imaging magnetic materials exemplified by investigating the fractured surface of a demagnetized NdFeB sample. Images are acquired using the annular Backscatter Detector (aBSD) in GeminiSEM 460 at 3 kV without bias, taking advantage of the 6-segmented aBSD detector having angle selective BSE detection. Left: The BSEs with a low take-off angle contain more compositional surface information and are detected by the inner ring of the aBSD detector. This results in images with high material contrast. Center: The BSEs are detected by the middle ring, providing images with a mixture of surface topographical and compositional information. Right: The BSEs with a high take-off angle contain mainly topographical surface information and are detected by the outer ring, which is divided into four individual segments. (The segments of the detector that were active during imaging are highlighted in green, respectively.)

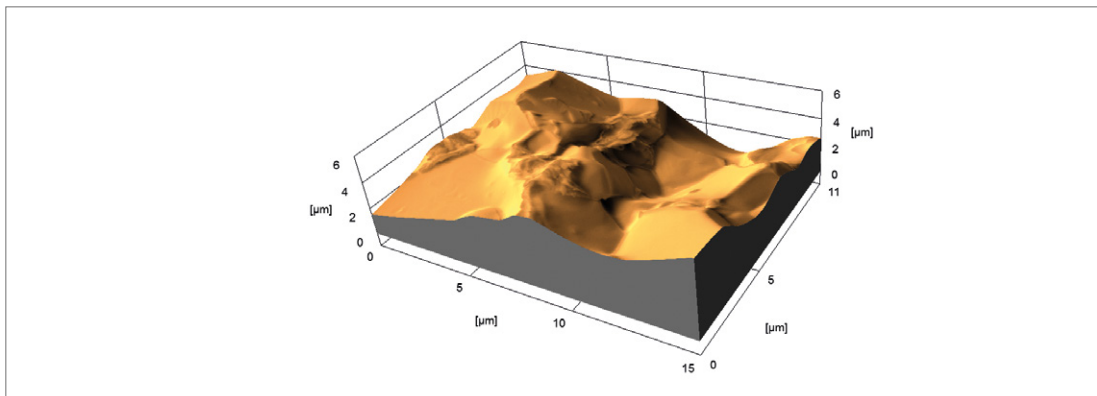

Visualization of surface topography with the aBSD detector and the 3DSM software module for 3D surface modeling. Images collected with the outer, segmented ring of the aBSD diode, are used by 3DSM to create a model of the fractured surface. Visualize surface topography and use functions for quantification and measurement.

# ZEISS GeminiSEM at Work: Materials Sciences

- › In Brief
- › The Advantages
- › **The Applications**
- › The System
- › Technology and Details
- › Service

## Nanoscience & Nanomaterials

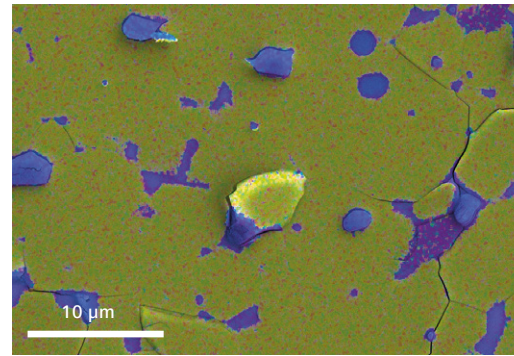
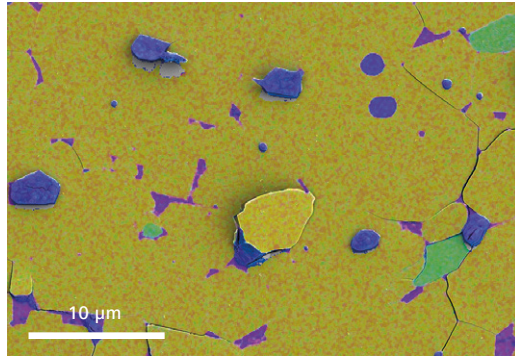

After boron (in green) is added to the results shown in the elemental map, it is easy to resolve the fine distribution of B against Nd (pink) on the map taken at 3 kV (left)—whereas the map taken at 15 kV (right) shows fewer details (oxygen in blue). EDS analytics done with GeminiSEM 460.

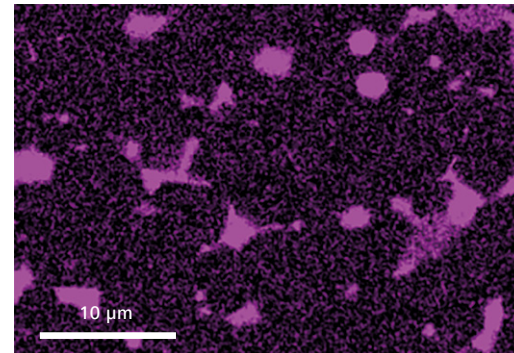
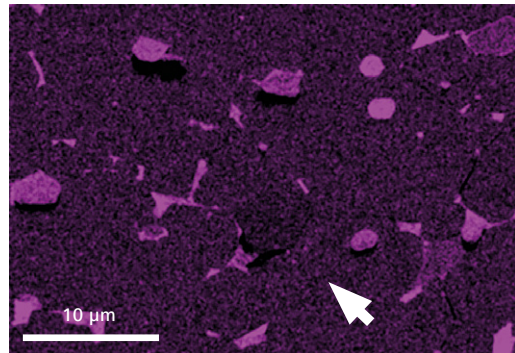

A comparison of elemental maps at 3 kV (left) and at 15 kV (right) shows the advantage of low voltage EDS mapping when aiming for high spatial resolution (Nd in pink). The low voltage map taken at 3 kV shows more details when characterizing the Nd distribution in the material, even nanometer sized particles within the matrix (arrow). EDS analytics done with GeminiSEM 460.

# ZEISS GeminiSEM at Work: Materials Sciences

- › In Brief
- › The Advantages
- › **The Applications**
- › The System
- › Technology and Details
- › Service

## Energy Materials

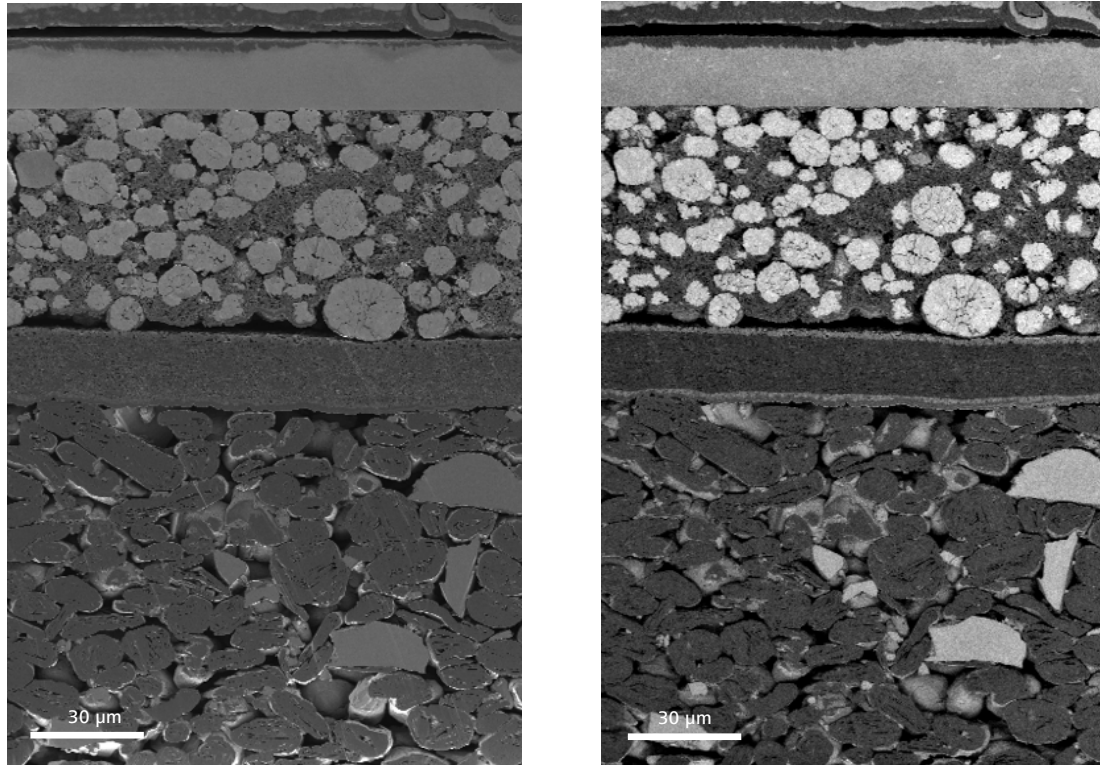

Cross-section of lithium ion battery containing NCM cathode, ceramic coated separator, and graphite & silicon anode imaged at 1 kV. The Inlens EsB signal (right) compared to the Inlens SE signal (left) provides added material contrast between graphite and silicon and reveals the ceramic coating on both sides of the polymer separator.

While the future of energy use depends on developing new functional materials and advanced devices such as batteries, solar cells, and fuel cells, how these devices perform is intricately linked to their microstructure and the microstructure of the materials that compose them. These complex material systems rely on the interplay between many different materials to operate effectively. In research, you must first try to understand the microstructural details in their native environment before you can fully understand how a device will perform. From there you can begin to build effective models to explain processes and develop the next generation of materials that will underpin energy research in years to come.

### Typical Tasks and Applications

- Microstructure and device evaluation
- Defect analysis
- Phase distribution
- Pore and fracture quantification

### How You Benefit from ZEISS GeminiSEM

- Inlens SE and Inlens EsB detectors revealing material contrast to see details
- Image nanoscale interfaces with highest resolution capabilities
- Sensitive materials observed in their native state with high performance low kV capabilities
- Complex multi-material systems analyzed easily with high beam current, high resolution analytics



# ZEISS GeminiSEM at Work: Materials Sciences

- › In Brief
- › The Advantages
- › **The Applications**
- › The System
- › Technology and Details
- › Service

## Energy Materials

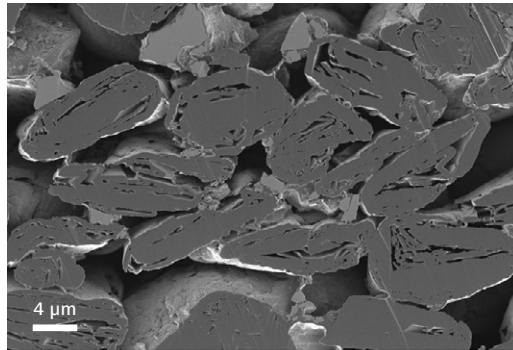

Graphite and silicon particles in cross section in the anode of a conventional lithium ion battery imaged at 1 kV with Inlens SE detector.

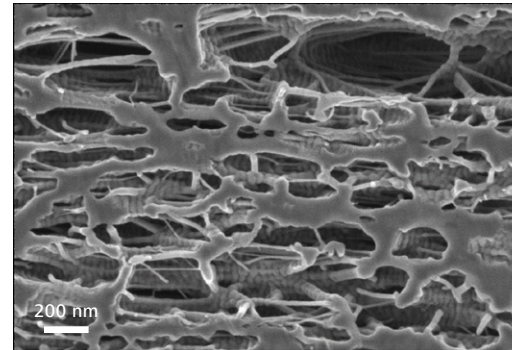

Cross-section image of an uncoated polymer separator membrane from a lithium ion battery imaged at 1 kV with the Inlens SE detector. Delicate materials such as this separator must be imaged at low voltages to avoid damaging the intricate structure.

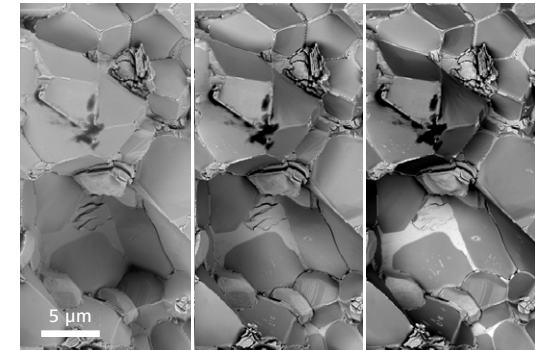

Fractured surface of a (demagnetized) NdFeB permanent magnet, such as those used in NEV motors. The sample is imaged at 3 kV and 7 mm working distance. The three different contrasts are obtained by the outer, middle, and inner ring of the aBSD detector, respectively.

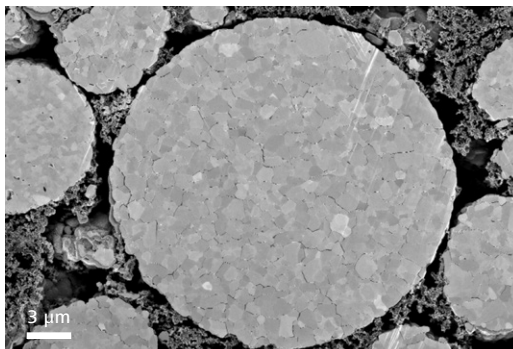

NCM622 cathode particles after 500 charge cycles, from a conventional lithium ion battery imaged at 1 kV with Inlens SE detector. The primary particles can be resolved within the larger secondary particle, which shows cracks resulting from the aging process.

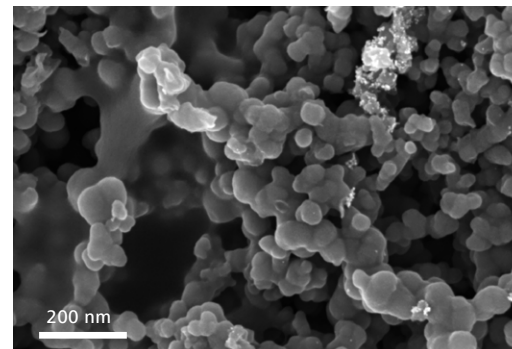

Surface of an uncoated polymer electrolyte fuel cell microporous layer, imaged at 2 kV with the Inlens SE detector. Individual carbon nanoparticles are agglomerated with binder to form the highly porous structure, while isolated platinum nanoparticles with diameter <math>< 10\text{ nm}</math> can be seen decorating some regions.

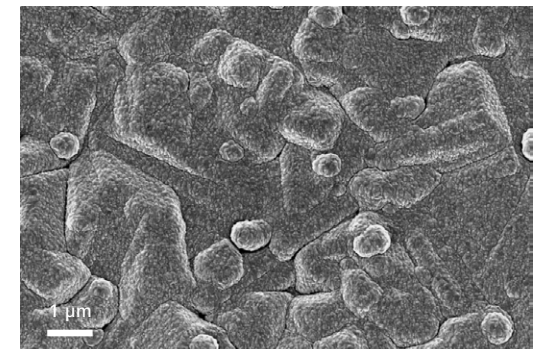

Surface of a CIGS solar cell on an alumina substrate at 1.8 kV using the Inlens SE detector to highlight the surface topography.

# ZEISS GeminiSEM at Work: Materials Sciences

- › In Brief
- › The Advantages
- › **The Applications**
- › The System
- › Technology and Details
- › Service

## Engineering Materials

The demand for materials that meet ever-evolving structural needs has spawned many innovations in recent years. These include advanced alloys that are resistant to heat or fatigue, high strength-to-weight ratio composite structures, environmentally-durable and self-healing concrete, and reliable, robust protective coatings—and then there are the innovations in the pro-

cesses of additive manufacturing or 3D printing. It takes a detailed understanding of a material's properties throughout its life cycle to develop or improve engineering products of this caliber. That's why microscopy is central to studying features of interest such as grain structure and sizes, texture, phases and phase transitions, volume fractions, inclusions and impurity distributions, as well as surface finish.

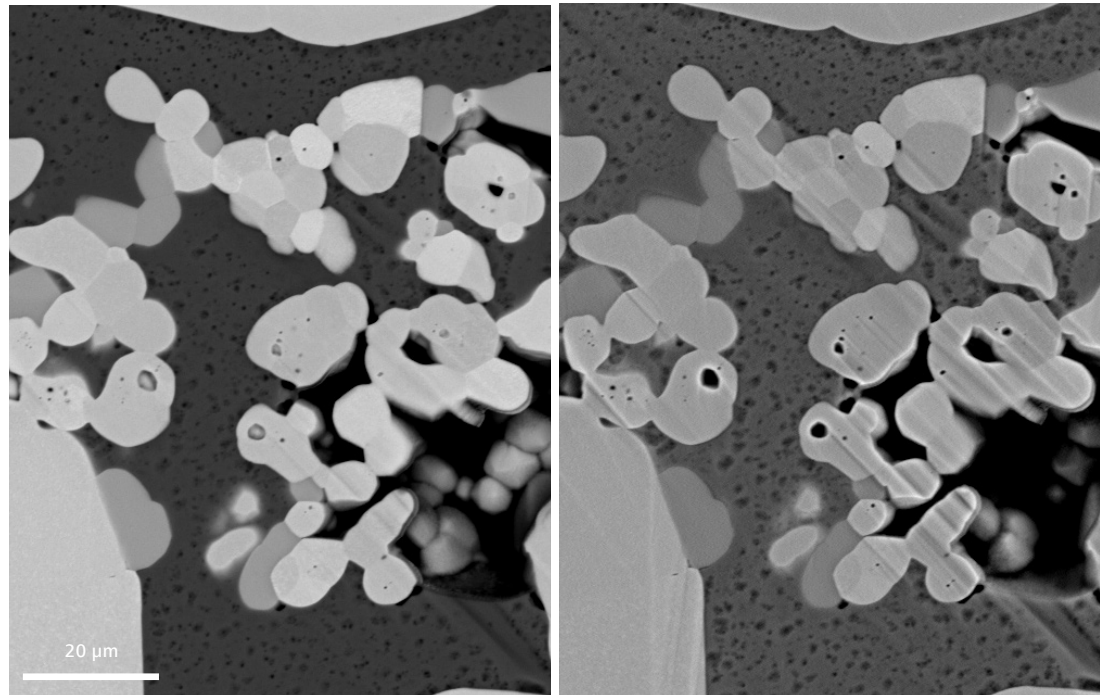

A copper-tungsten alloy imaged to reveal the material contrast (left) and topographical contrast (right). Brighter particles are tungsten particles comprising of single or several grains. The darker matrix is copper with nano-porosity.

## Typical Tasks and Applications

- Versatile materials characterization at sub-nm resolution, with superior contrast and sharpness
- Metallography and fracture analysis
- Characterization of *in situ* material behavior under varying conditions
- Generation of experimental data for validation and improved fidelity of simulation models

## How You Benefit from ZEISS GeminiSEM

- Achieve nanometer resolution routinely both with enhanced material and topographical contrast
- Select optimized settings for each sample from a choice of options – such as Tandem decel mode for ultra high resolution or different imaging contrasts from a variety of detectors e.g. SE2, InLens SE, EsB or AsB
- Switch rapidly between different applications for correlative and *in situ* microscopy, enabled by the long-term beam stability and effortless parameter optimization
- Characterize non-conducting samples with Variable Pressure (VP) technology for imaging non-conductive advanced structural materials such as composite materials, fibers, polymers and concrete
- Intelligent imaging and automated workflows for efficient user interaction for correlative and *in situ* microscopy

# ZEISS GeminiSEM at Work: Materials Sciences

- › In Brief
- › The Advantages
- › **The Applications**
- › The System
- › Technology and Details
- › Service

## Engineering Materials

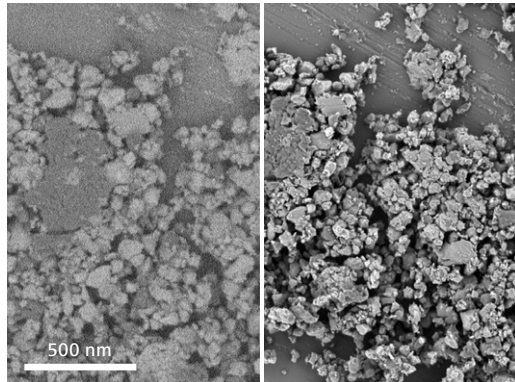

Cross-section of  $\text{Al}_2\text{O}_3/\text{ZrO}_2$ -3 mol %  $\text{Y}_2\text{O}_3$  nanocomposite powder imaged with the BSE detector at 1 kV landing energy with no bias (left) and at 1 kV landing energy with 5 kV bias (right), providing enhanced material contrast and sharpness.

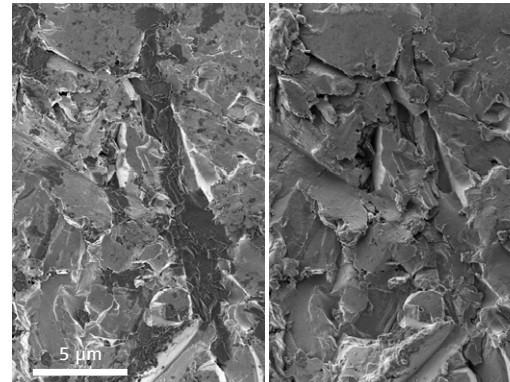

Cross-sectional image of stainless steel surface after surface preparation using sand blasting. The crushed  $\text{SiO}_2$  shows positive charging on the left image. Contrast visible only at large working distance of 5 mm (left) versus a closer working distance of 1 mm (right).

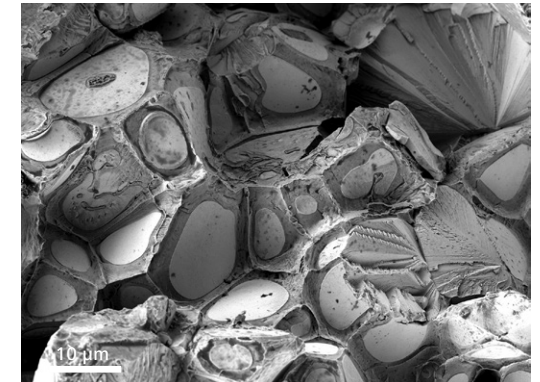

Cross-section of an advanced alloy material imaged at 3 kV in HV mode, revealing a tungsten core material surrounded by a steel matrix when imaged with Inlens backscatter mode at low voltage.

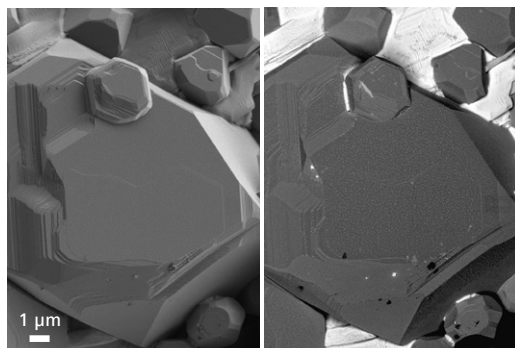

Topography and material contrast of a ceramic, used e.g. in crucibles, visualized by using the Everhart-Thornley SE2 detector (left) and the Inlens EsB detector (right).

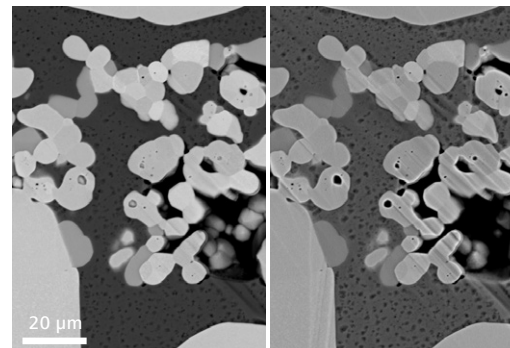

A copper-tungsten alloy imaged using aBSD detector at a landing energy of 5 kV in Tandem decel mode. Use various segments of the aBSD detector to switch on different contrasts. For higher material contrast use inner segments (left) or achieve higher topographical contrast with the outer segments (right).

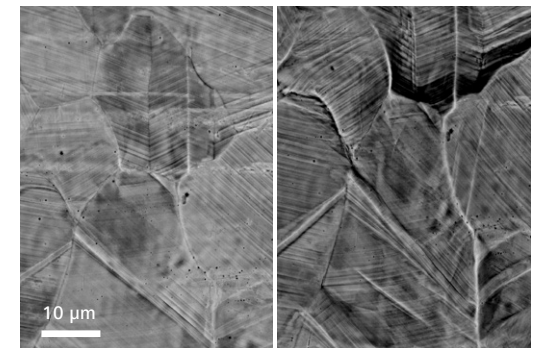

A stainless steel sample imaged under in situ tensile load test, using the AsB detector. Images have extremely high contrast and capture the slip bands' formation during in situ loading as shown in the images of before (left) and after loading (right).

# ZEISS GeminiSEM at Work: Materials Sciences

- › In Brief
- › The Advantages
- › **The Applications**
- › The System
- › Technology and Details
- › Service

## Bio-inspired Materials, Polymers and Catalysts

Whether you are designing novel materials, optimizing processes or discovering new surface properties of bio-materials, polymers and catalysts, it is essential to have structural and functional characterizations of these materials in high resolution scanning electron microscopy. However, often these samples are non-conductive and beam-sensitive so imaging or testing them *in situ* in the SEM is seldom straightforward. That makes the low kV, low vacuum and low beam current imaging performance of the GeminiSEM Family invaluable to researchers who can capitalize on such extreme sample flexibility.

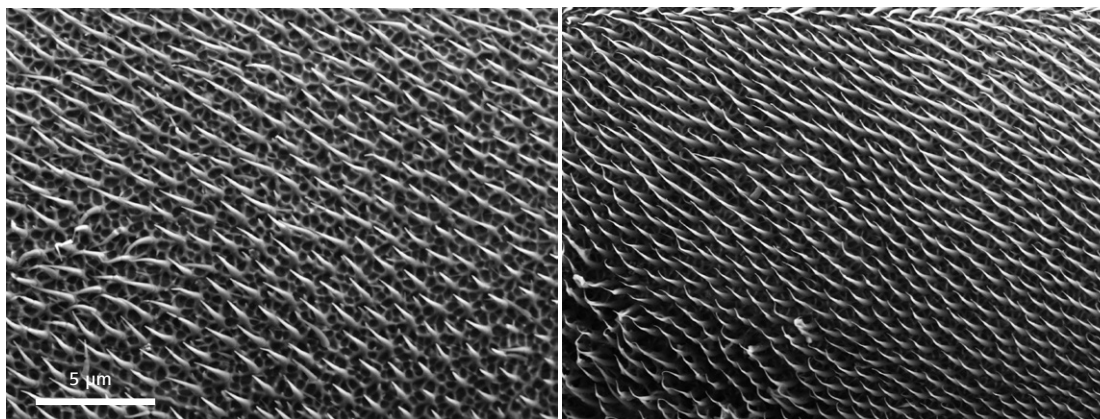

*Bio-inspired replication of gecko skin surface (right) and natural gecko skin (left) with bactericidal properties. The synthetic spinulated surface inspired by gecko skin is used for healthcare purposes. The nanostructured spinules can be very effective at repelling bacteria. 3 kV, NanoVP 100 Pa, C2D detector, samples: natural Gecko skin (left) and siloxane polymer (right) without conductive coating.*

## Typical Tasks and Applications

- Surface characterization and evaluation
- Structural analysis, segmentation and quantification
- Correlative multiscale characterization due to typical hierarchical structure of some bio-materials
- Failure analysis and process control

## How You Benefit from ZEISS GeminiSEM

- Imaging non-conductive samples using superior low-kV sweet spots without conductive coating and charging effects
- High resolution imaging and analytical characterization of non-conductive samples using market leading NanoVP
- Imaging beam sensitive samples using the low beam current mode of the GeminiSEM 460
- Reveal superior contrast and details with Inlens SE, EsB and C2D detectors

# ZEISS GeminiSEM at Work: Materials Sciences

- › In Brief
- › The Advantages
- › **The Applications**
- › The System
- › Technology and Details
- › Service

## Bio-inspired Materials, Polymers and Catalysts

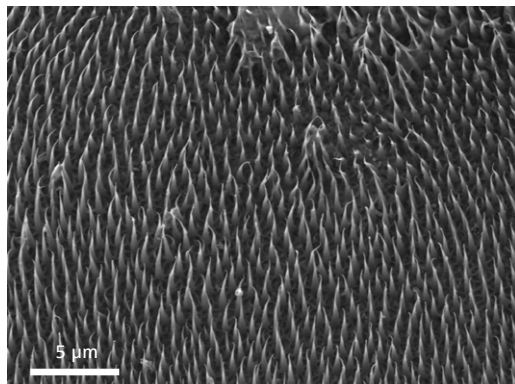

*Bio-inspired replication of gecko skin surface in siloxane polymer without conductive coating. Mimicking natural gecko skin's bactericidal properties, this synthetic spinulated surface is used in healthcare where the nanostructured spinules can be very effective in repelling bacteria. Imaged at 3 kV, NanoVP 100 Pa, with C2D detector.*

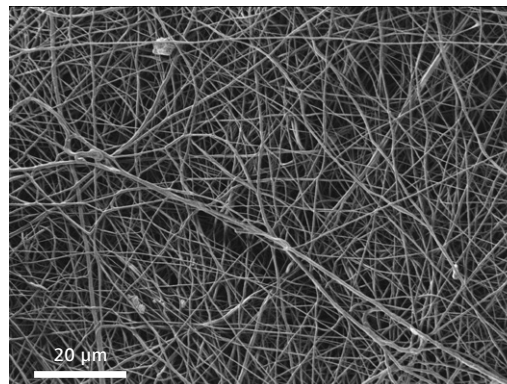

*Cross-linked gelatin nanofibrous scaffold for tissue engineering. The gelatin mat is stabilized in a formaldehyde-rich atmosphere for 30 min. which results in chemical cross-linking of the fibers, 1 kV, SE2 detector, sample without conductive coating. Sample: courtesy of Biological and Macromolecular Materials group at Fraunhofer IMWS, Halle (Saale), Germany.*

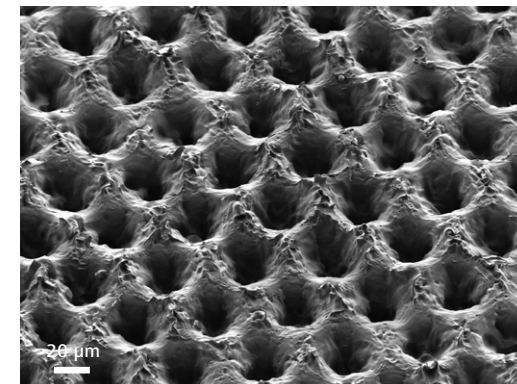

*Polyurethane film, after surface structuring with roll-to-roll imprinting. This surface structure is strongly influencing the wetting behavior towards superhydrophobic properties. Sample: courtesy of G. Umlauf, Fraunhofer IGB Stuttgart, Germany.*

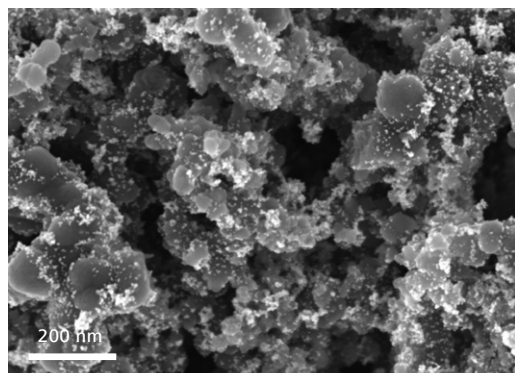

*Proton exchange membrane fuel cell electrode with Pt catalyst nanoparticles. Grain size distributions and Pt catalyst nanoparticles can be analyzed using GeminiSEM 560. 2 kV, Inlens SE.*

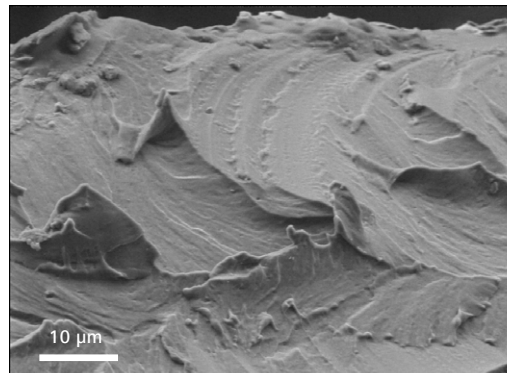

*The ruptured surface of a polymer imaged under Variable Pressure gives insight into adhesion of two attached polymers. SEM used for failure analysis and for quality control of the polymer welding process. 5 kV, working distance 5 mm, 45 Pa, C2D detector.*

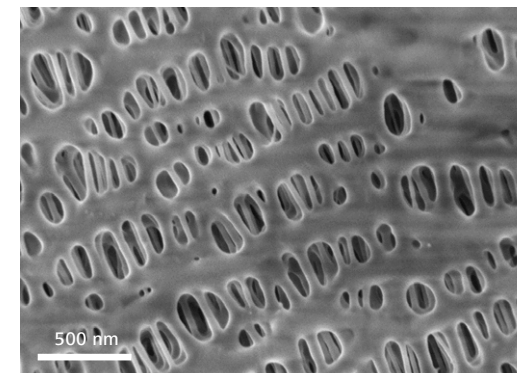

*The polymer separator film is a key component of a lithium ion battery. The thickness, porosity, and high temperature properties of the separator film determine its performance, reliability, safety, and the life-time. As a polymer, it is very beam sensitive and non-conductive and thus benefits from GeminiSEM's low kV imaging performance. Imaged using GeminiSEM 560, at 700 V with 6 pA, using Inlens SE without conductive coating.*

# ZEISS GeminiSEM at Work: Industry

- › In Brief
- › The Advantages
- › **The Applications**
- › The System
- › Technology and Details
- › Service

## Microscopy Solutions for Industry

When carrying out industrial-quality failure analysis or environmental research, a GeminiSEM is your solution of choice to improve and sustain quality and reliability of products. Only then can you be sure that these products will leave the factory with a defined, measurable, and documented standard of quality. If a failure occurs, your key task is to identify its root cause as quickly as possible. This will help you decide which corrective and preventive actions need to be applied as part of good manufacturing practice. The assembly of different components and materials can be challenging in terms of reliability and possibly a source of defects. To pinpoint the root causes of such system failures, you might need to employ several methods and a broad variety of applications. That's why classic fracture and metallographic analyses are state-of-the-art practice, along with methods ranging from electronic failure analysis to compositional purity investigations.

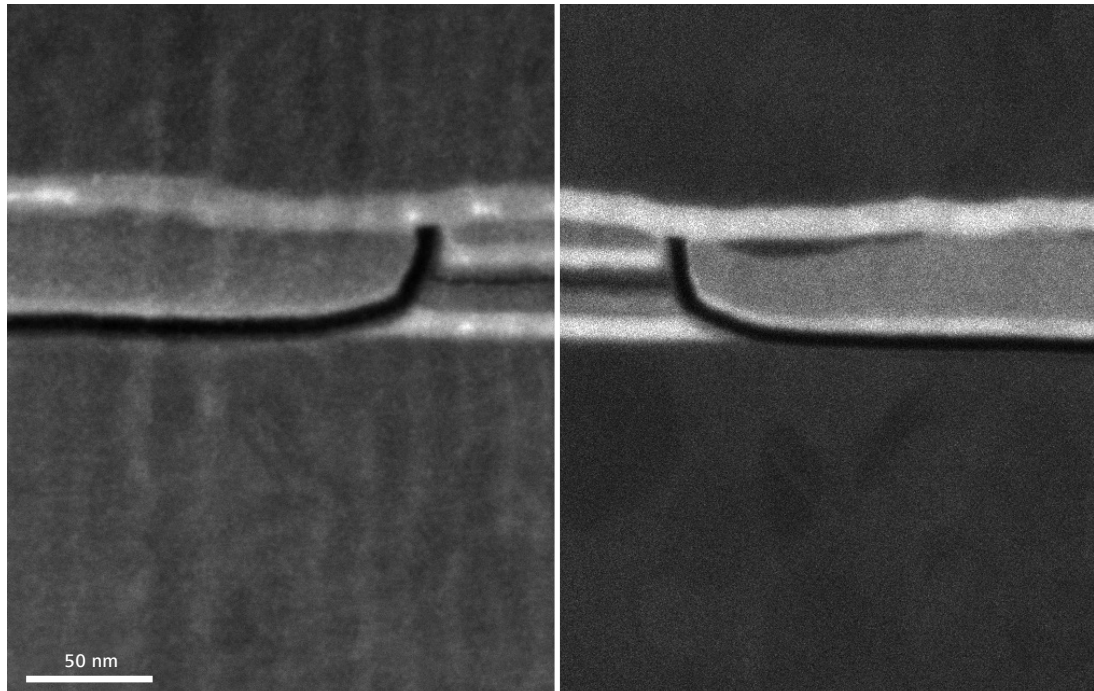

Data storage hard disk read head imaged with Inlens SE detector (left) and Inlens EsB detector (right).

## Typical Tasks and Applications

- Failure analysis on mechanical, optical or electronic components
- Fracture analysis and metallography
- Surface, microstructure, and device characterization
- Compositional and phase distribution
- Impurity and inclusion determination

## How You Benefit from ZEISS GeminiSEM

- Convenient and reliable performance ranging from surface sensitive nanometer resolution and low-voltage imaging to high beam current nanoanalysis
- Failures determined easily, right down to nanometer scale.
- Inlens SE and EsB detectors revealing material contrast to expose details
- Nanoscale interfaces imaged with highest resolution capabilities
- High beam current and high resolution analytics for easy analysis of complex multi-material systems
- Microstructure, chemistry, crystal phases, and strain of any metal investigated —without limitations

# ZEISS GeminiSEM at Work: Industry

- › In Brief
- › The Advantages
- › **The Applications**
- › The System
- › Technology and Details
- › Service

## Microscopy Solutions for Industry

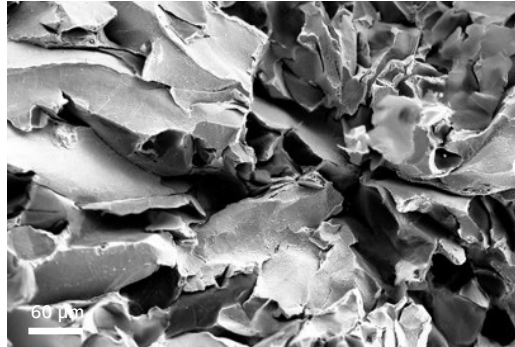

Fracture surface – brittle failure of a steel sample in tension. Sample: courtesy of The Test House, Cambridge, United Kingdom.

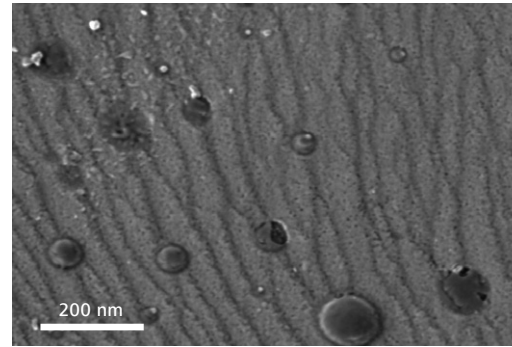

Inclusions in steel, Inlens SE detector, 500 V.

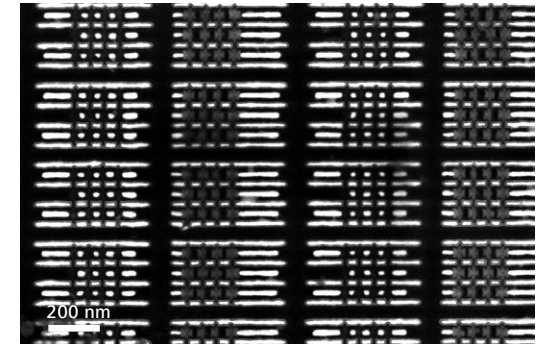

FinFET transistor, top view, 22 nm technology, 3 kV, pure BSE imaging using Inlens EsB, high material contrast.

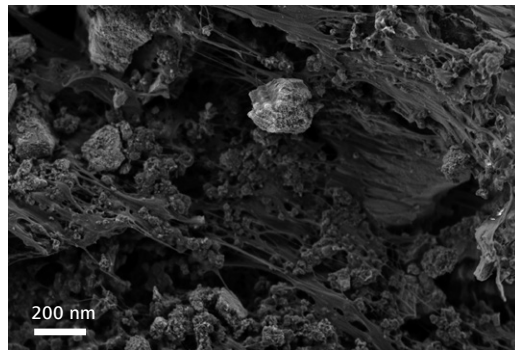

Lithium ion battery cathode shows no beam damage of sensitive binder material at 500 V. Sample: courtesy of T. Bernthaler, Materials Research Institute Aalen, Aalen University, Germany.

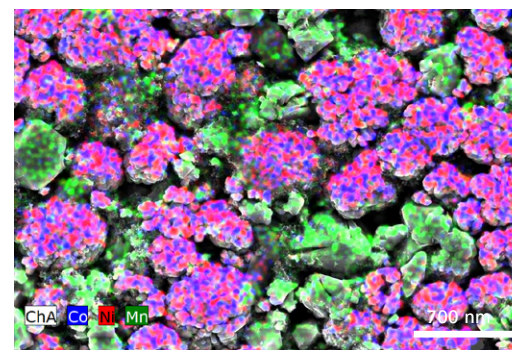

Lithium ion battery cathode. EDS compositional mapping shows main constituents of the different oxides. Sample: courtesy of T. Bernthaler, Materials Research Institute Aalen, Aalen University, Germany.

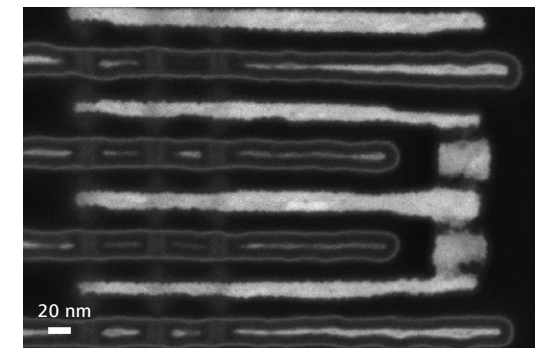

Semiconductor, computer chip, Inlens EsB detector, at 3.5 kV.

# ZEISS GeminiSEM at Work: Electronics and Semiconductor

- › In Brief
- › The Advantages
- › **The Applications**
- › The System
- › Technology and Details
- › Service

## Semiconductor Device Design and Failure Analysis

As transistor and interconnect sizes approach the hard limits set by physics, material complexity increases and three-dimensional architectures such as FinFET and Gate-all-around transistors are becoming increasingly common. This brings many new challenges to semiconductor process control, and failure analysis, and you will need electron microscopy to keep pace with similar improvements in microscope performance. The new GeminiSEM family comes with failure analysis techniques that underpin the reliability of new generation devices, and with resolution improvements to match the innovations step by step as transistors scale down to single digit nanometer features. GeminiSEM's linearity, field of view, and high contrast enable imaging and characterizing electronic devices efficiently and in high quality.

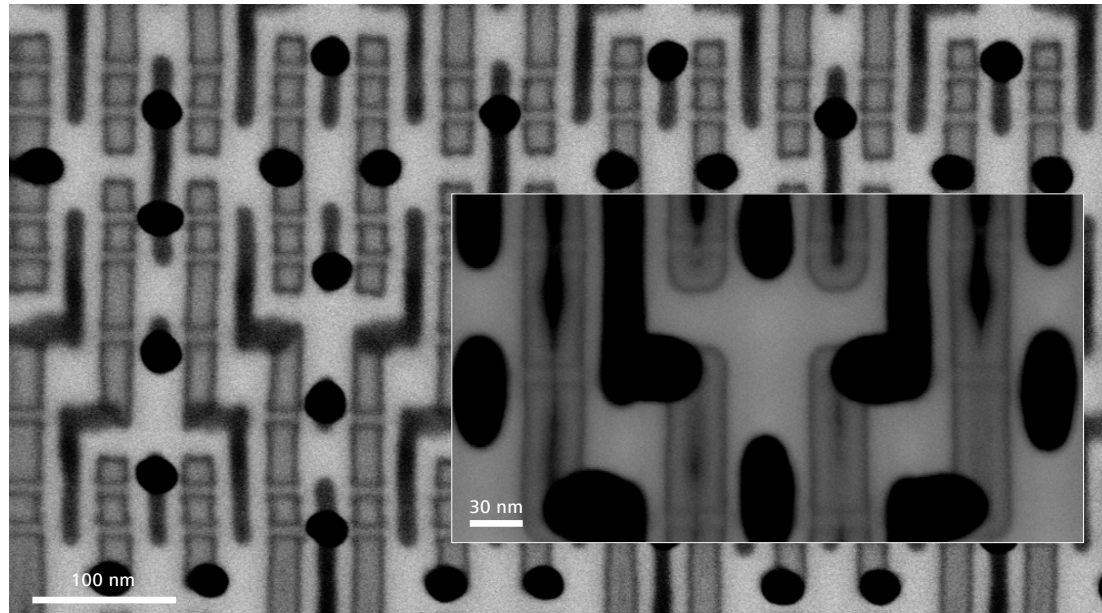

The aBSD detector at high EHT (here at 30 kV) shows deeply-buried structures such as FinFET gates, tungsten plugs, and tin liner (inset) with exceptional resolution and contrast. GeminiSEM's excellent contrast at high resolution can guide the failure analysis engineer in the TEM site selection workflow.

## Typical Tasks and Applications

- Construction analysis and benchmarking
- Passive voltage contrast
- Subsurface analysis
- Electronic property measurement with probing
- TEM site selection

## How You Benefit from ZEISS GeminiSEM

- Inlens SE and EsB detectors revealing material contrast to show details
- Excellent signal-to-noise and resolution for low-kV applications such as passive voltage contrast
- Electronic properties of devices observed in their native state with optional probing and amplification accessories
- Superb contrast and resolution of subsurface features with the aBSD detector



# ZEISS GeminiSEM at Work: Electronics and Semiconductors

- › In Brief
- › The Advantages
- › **The Applications**
- › The System
- › Technology and Details
- › Service

## Semiconductor Device Design and Failure Analysis

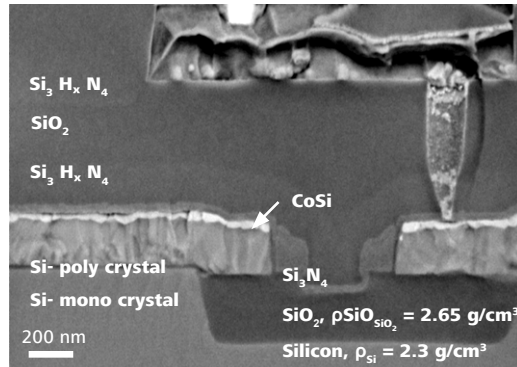

As the material complexity of electronics continues to increase, contrast can be a boon to device analysis. The material contrast enabled by the energy selective Inlens EsB detector is unique to GeminiSEM and can resolve all material layers used in today's integrated circuits.

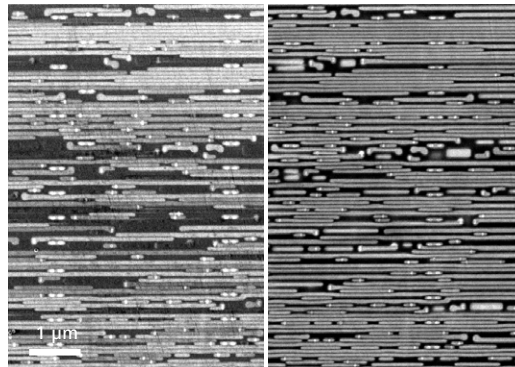

The electronic properties of passive voltage contrast can be compared to subsurface structural information by increasing the beam landing energy, in this case using 1 kV for PVC (left) and 3 kV for the subsurface imaging (right). The superb stability of the Gemini column enables a seamless workflow.

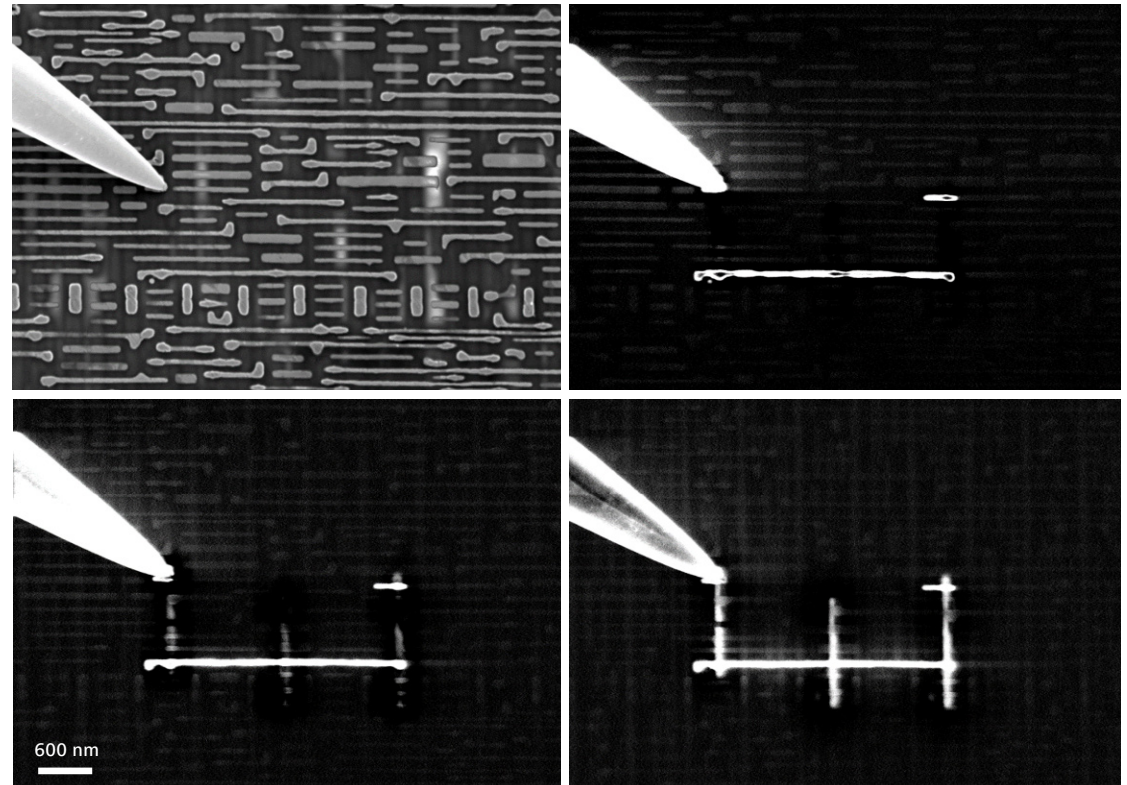

Probing during imaging can give further insight into function. Here, electron beam absorbed current (EBAC) shows the connectivity of a circuit with a probe tip landed at one node (upper left). EBAC at increasing tensions (upper right 2 kV, lower left 5 kV, lower right 8 kV) shows the electronic structure at lower metal layers.

# ZEISS GeminiSEM at Work: Life Sciences

- › In Brief
- › The Advantages
- › **The Applications**
- › The System
- › Technology and Details
- › Service

## Life Sciences

As varied as the branches are in life sciences—from zoology and plant sciences to developmental biology, neuroscience research, cell biology or general ultrastructural investigation—microscopy is a common and essential tool. You may be characterizing biological samples in detail, uncovering cellular or subcellular processes or exploring the ultrastructure of a sample. Scanning electron microscopy allows 3D imaging of, for example, brain samples with a resolution that resolves even cell-cell contacts. In cell biology, cancer research and neuroscience, you often need to combine complementary microscopy technologies or contrasting techniques to answer your scientific question. Learn how you connect multimodal data from your 3D cell culture, spheroids, organoids or even whole organisms to get a holistic view on your samples.

## Typical Tasks and Applications

- Characterization of topology
- Imaging sensitive, non-conductive, outgassing, or low contrast samples
- Visualizing the ultrastructure of cells, tissues etc. at high resolutions
- Imaging very large areas such as serial sections or block faces

## How You Benefit from ZEISS GeminiSEM

- Topology revealed in high vacuum with SE2 and Inlens SE detector and composition with the aBSD
- Non-conductive specimens imaged under VP or NanoVP—for example, with the C2D detector
- High resolution backscatter imaging or the aSTEM detector available for high resolution imaging of ultrastructure
- Large areas of serial sections or block face samples imaged with Array Tomography or by using the Focal CC option with 3View

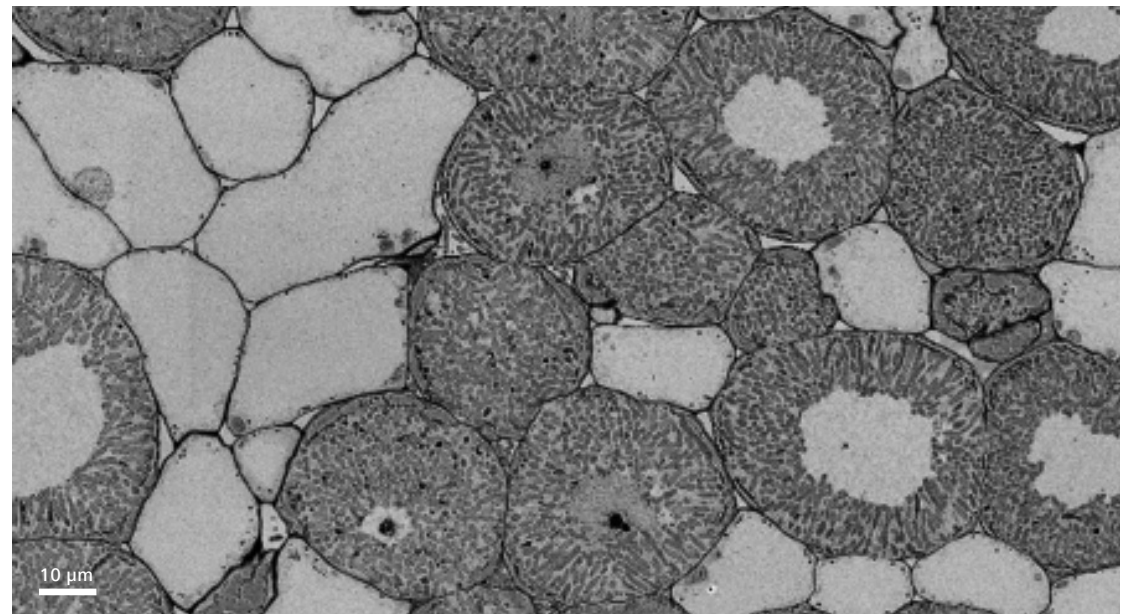

Root nodules of Fabaceae beans. Large field of view imaging enables the statistical analysis of infections, as in these root nodules that are infected with root nodule bacteria. The aligned image stacks enable the building of 3D volumes out of serial sections. Imaged with GeminiSEM 360 and Atlas 5 Array Tomography.

# ZEISS GeminiSEM at Work: Life Sciences

- › In Brief
- › The Advantages
- › **The Applications**
- › The System
- › Technology and Details
- › Service

## Characterization: From Micrometers to Nanometers

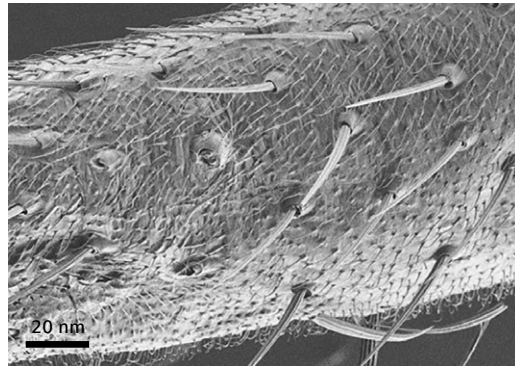

*GeminiSEM 360 enables scientists to analyze sensitive samples, even under low voltage conditions which is ideal to avoid sample damage. This insect leg was imaged at 1 kV.*

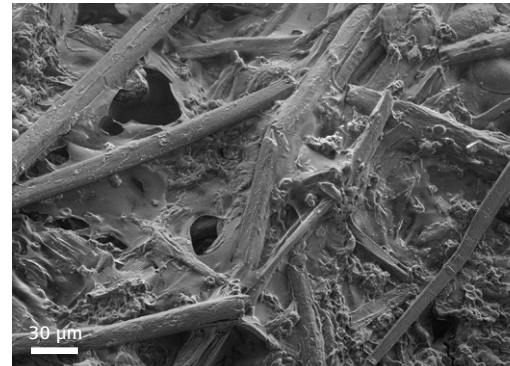

*Nanometer scaled structural details on the surface of a wasp nest. Vegetative fibers form the wall of the nest, glued together with an oral secretion from chewed wood. The texture of the fibers gains stability by preferential direction. Imaged at 5 kV with GeminiSEM 560, Variable Pressure, C2D detector.*

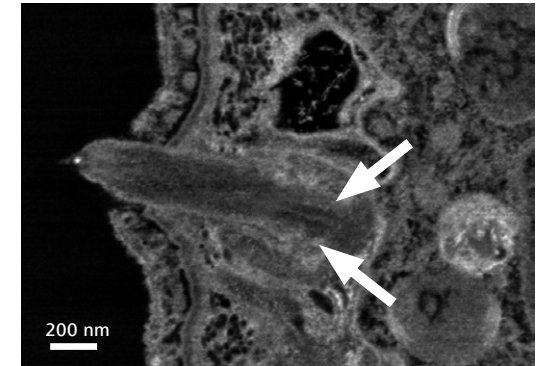

*Cilia, imaged with the BSD detector in GeminiSEM 460. Centrin are special proteins in the cilia of eukaryotes. The centrin-rich region of the basal apparatus is clearly visible (arrow). The BSD detector used here illustrates the smallest differences in heavy contrast. Sample: courtesy of P. Purschke, University of Osnabrück, Germany.*

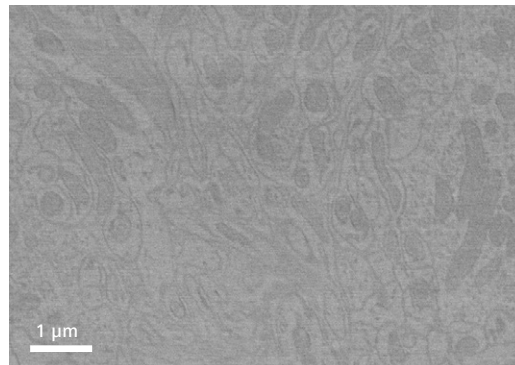

*Life sciences often deal with low contrast samples and approaches such as correlative microscopy are especially lacking features rich in contrast. With Tandem decel you can introduce an electrical deceleration or bias between the sample and objective lens and achieve a dramatic increase in contrast. The figure shows a low contrast brain section imaged without the Tandem decel option (left). Applying Tandem decel (right) increases contrast to such an extent that all cell organelles are clearly visible at high resolution. Imaged with GeminiSEM 560.*

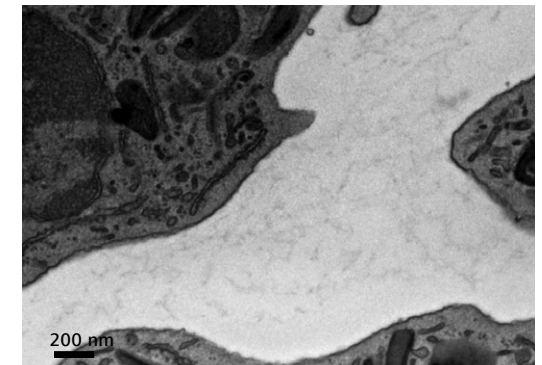
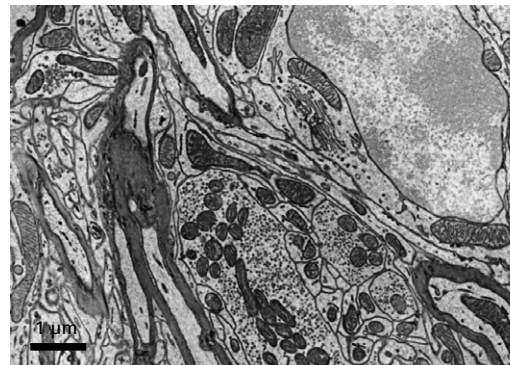

*Neurophile granulocytes offer a perfect example of how features such as the Nano-twin lens of GeminiSEM 560 allow imaging under low voltage conditions and provide the best possible contrast. Coatomers of vesicles are clearly visible. Image: courtesy of I. Wacker, University of Heidelberg, Germany. Imaged with GeminiSEM 560.*

# ZEISS GeminiSEM at Work: Life Sciences

- › In Brief
- › The Advantages
- › **The Applications**
- › The System
- › Technology and Details
- › Service

## Imaging Non-coated Specimens With NanoVP

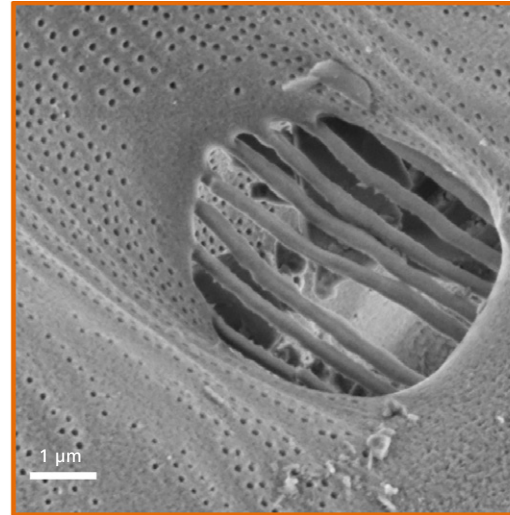
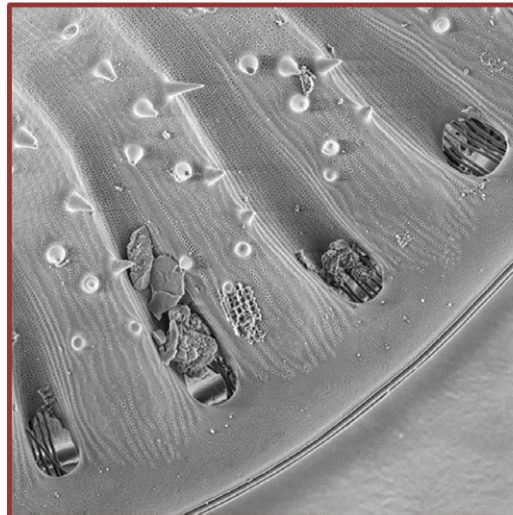
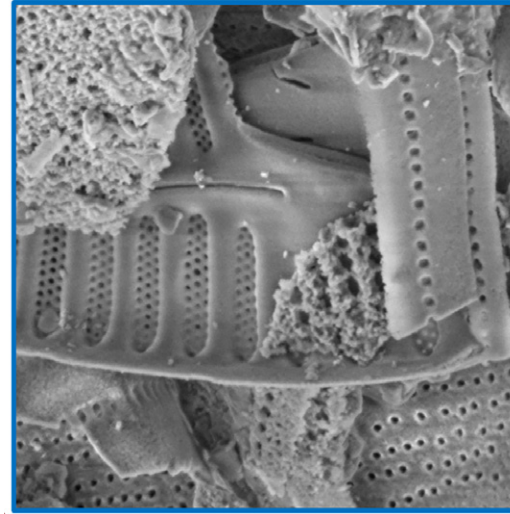
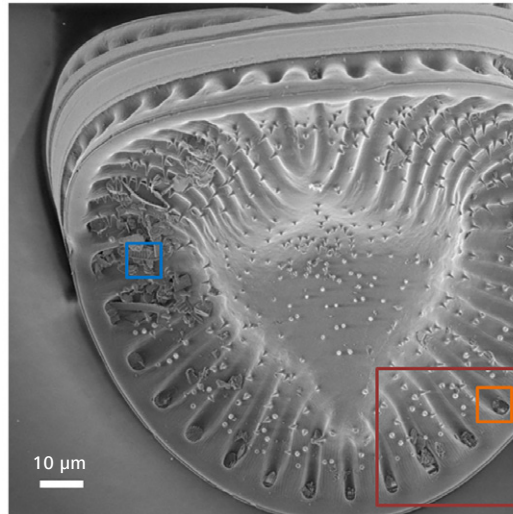

*NanoVP brings you the unique advantage of being able to use your Inlens SE detector in combination with variable pressure. This enables high resolution structural imaging of samples prone to charging. Typically, higher resolution requires a higher probe current and so the probability of charging is elevated. Now, using NanoVP, you can image the delicate features of an uncoated diatom at 2 kV with a resolution of 4 nm/pixel under variable pressure conditions. Nevertheless, in this close-up view the surface as well as deeper lying structures can be visualized artefact-free and without loss of resolution, thanks to NanoVP. The detailed ultrastructure of the diatom cytoskeleton is visualized in the pictures. Imaged with GeminiSEM 560.*

# ZEISS GeminiSEM at Work: Life Sciences

- › In Brief
- › The Advantages
- › **The Applications**
- › The System
- › Technology and Details
- › Service

## Tissue, Cells or Viruses & STEM Imaging

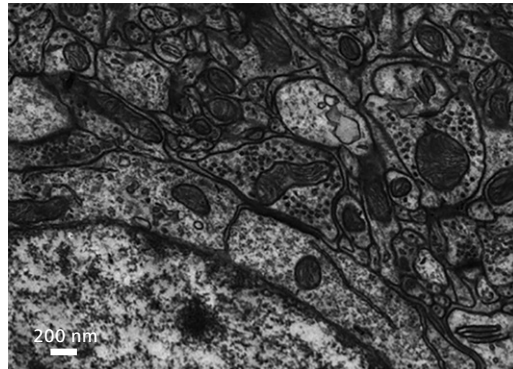

Ultrathin section of the upper brain cortex. GeminiSEM 460 provides the best possible resolution combined with fast image acquisition. Structural details such as vesicle coatings are clearly visible in this STEM image.

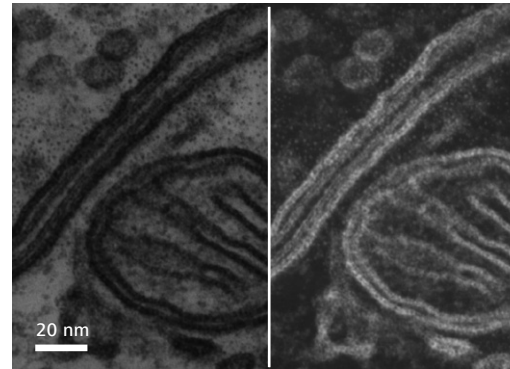

The advanced capabilities of GeminiSEM 560 combined with the STEM detector allow you to image ultrastructural details to such an extent that lipid bilayers become visible in biological specimens such as brain cells. Mouse brain sample: courtesy of M. Cantoni, EPFL Lausanne, Switzerland.

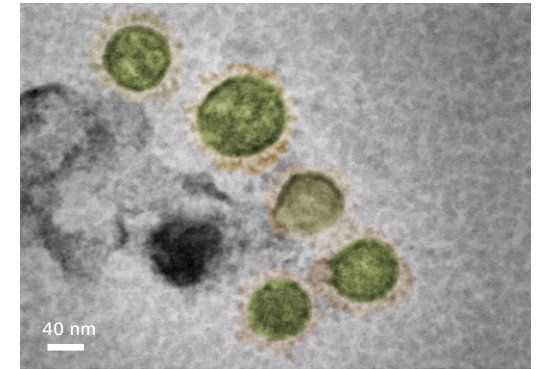

SARS-CoV-2 grown in a tissue culture and inactivated by chemical fixation. The virus was negatively stained. Imaged with GeminiSEM 560, aSTEM, false colored. Sample: courtesy of M. Hannah, Public Health England, United Kingdom.

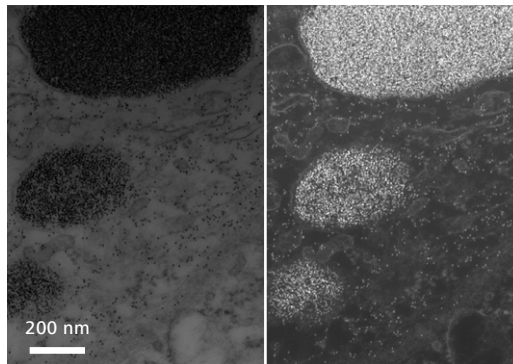

Guinea pig liver, ultrathin section, hemosiderosis, fixed with osmium tetroxide in araldite. No further poststaining with additional heavy-metal salts was performed. Single ferritin molecule (diameter approximately 8 nm) can be clearly identified in STEM. Left: brightfield. Right: HAADF image (high-angle annular darkfield), at 28 kV.

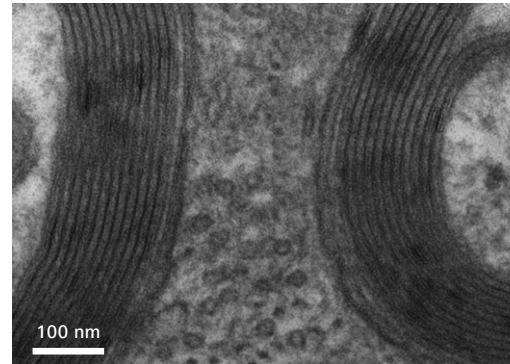

Mouse brain tissue, ultrathin section, detail of Myelin sheaths, STEM, brightfield, at 28 kV.

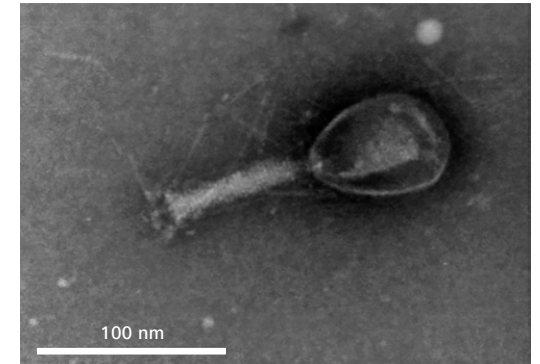

The high sensitivity of the STEM detector allows the use of low voltage electrons with high scan speeds, thus enabling fast STEM imaging with the highest resolution. The picture shows a negative stained T4-Phage imaged with a STEM detector. Notice structural details such as the helical tail as well as the tail fibers associated with the virus. Image: courtesy of D. Frey, S. Modla, and J. Caplan, University of Delaware, USA. Imaged with GeminiSEM 560.

# ZEISS GeminiSEM at Work: Life Sciences

- › In Brief
- › The Advantages
- › **The Applications**
- › The System
- › Technology and Details
- › Service

## **Benefit from 3View® with Focal Charge Compensation for Your Block Face Imaging**

Turn your ZEISS GeminiSEM 360 or GeminiSEM 460 into a super-quick high resolution 3D imaging system with 3View® technology from Gatan, Inc. 3View® is an ultramicrotome inside the SEM chamber that lets you acquire high resolution 3D data from resin-embedded cell and tissue samples—in the shortest possible time and the most convenient way. The sample is continuously cut and imaged so you can produce thousands of serial images in a single day. Unique ZEISS Gemini column technology makes the GeminiSEMs ideally suited to support this application. Now you can also enhance your GeminiSEM with Focal Charge Compensation to eliminate charging effects. ZEISS has released this gas injection system in collaboration with the National Center for Microscopy and Imaging. With Focal Charge Compensation, the result is spectacular image quality. When performing 3D nanohistology, electron microscopic investigation of tissue samples such as liver, kidney and lung by block face imaging is extremely valuable for pathological research. By using Focal Charge Compensation to eliminate charging, these charge-prone tissue samples can be imaged with high resolution and speed in three dimensions.

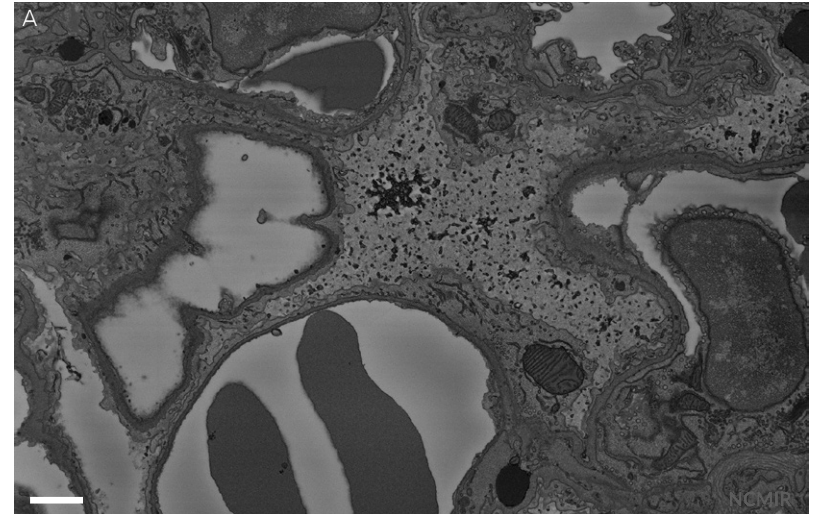

*Block face images of mouse lung tissue (A) with Focal Charge Compensation and (B) without Focal Charge Compensation. Scale bar: 1 micron. Images: courtesy of NCMIR, University of San Diego, US.*

# ZEISS GeminiSEM at Work: Life Sciences

- › In Brief
- › The Advantages
- › **The Applications**
- › The System
- › Technology and Details
- › Service

## Investigate Large Areas with Array Tomography, Serial Section & Block Face Imaging

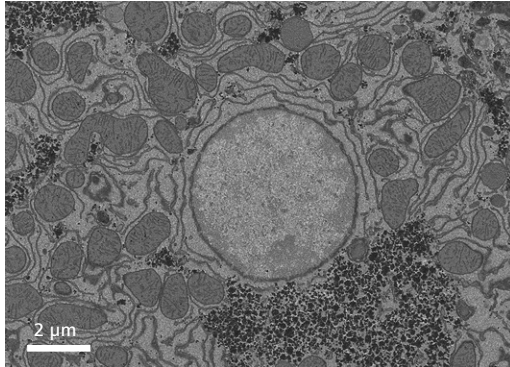

Here, one section out of a Gatan 3View® data set is imaged. VP capabilities combined with serial block-face technology allow you to section and image large fields of view without charging artefacts, thus providing optimal contrast. Typical hepatocytes with a large number of mitochondria are visible. Imaged with GeminiSEM 360.

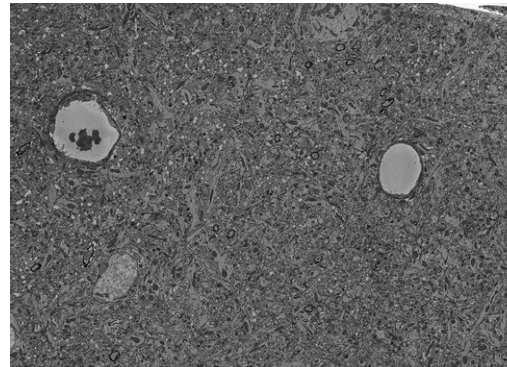

Large field of view of a brain section imaged using 3View® in combination with GeminiSEM 360. Even large unsputtered samples up to 1 mm<sup>2</sup> can be imaged artefact-free using a combination of variable pressure and low voltage imaging to eliminate charging artefacts. Imaged with GeminiSEM 360.



The movie shows an image stack acquired from a block face sample with a 3View® in a GeminiSEM with a double condenser system. Notice the rhodopsin discs and the insertion points. Image: courtesy of Ch. Genoud, FMI Basel, Switzerland. Imaged with GeminiSEM 460.

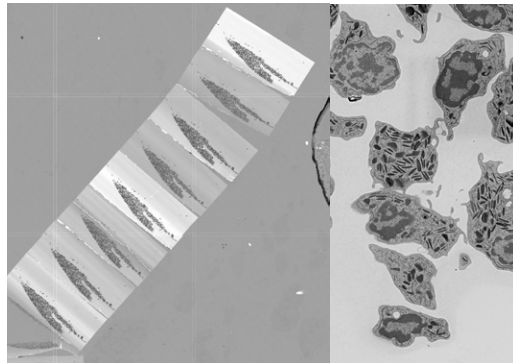

Statistical analysis of large fields of view in 3D is important in life science. Here, this is done using the Array Tomography module of Atlas 5 on serial sections of granulocytes, with different populations of granulocytes being analyzed. Left: overview on a ribbon of nine sections. Right: detail. Imaged with GeminiSEM 360.

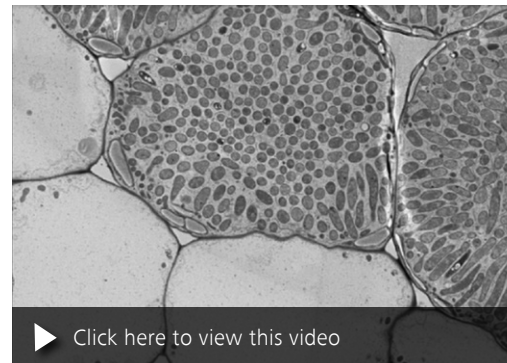

Root nodules of Fabaceae beans. The large field of view is also important for analyzing rare events in section ribbons or for statistical analysis of infections, as in these root nodules that are infected with bacteria. The Array Tomography module of Atlas 5 allows you to build 3D volumes out of serial sections. The movie shows 78 sections out of a one ribbon.

# ZEISS GeminiSEM: Meet the Family

- › In Brief
- › The Advantages
- › The Applications
- › **The System**
- › Technology and Details
- › Service



## **ZEISS GeminiSEM 360 with Gemini 1 Electron Optics**

- Forms the center of your core facility
- Spanning over applications and sample types
- Gemini 1 and single condenser
- Providing industry leading high resolution at low kV



## **ZEISS GeminiSEM 460 with Gemini 2 Electron Optics**

- Ideal for high throughput tasks in imaging and analytics
- Dedicated to your most challenging analytical workflows
- Gemini 2 and double condenser
- Extendable with an *in situ* solution lab for heating and tensile experiments



## **ZEISS GeminiSEM 560 with Gemini 3 Electron Optics**

- Your tool for ultimate sub-nanometer surface sensitive characterization
- Delivers the highest resolution in the family at all working conditions
- Gemini 3 with Nano-twin lens & Smart Auto-pilot
- Delivering sweet spots specifically for unique contrast imaging



# ZEISS GeminiSEM: Your Flexible Choice of Components

- › In Brief
- › The Advantages
- › The Applications
- › **The System**
- › Technology and Details
- › Service

**Airlock**

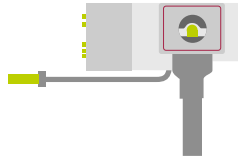

**Plasma Cleaner**



**In situ cleaning /  
Local Charge Compensation**



**WDS**

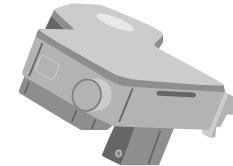

**STEM**



**EBSD**



**aBSD**



**C2D**

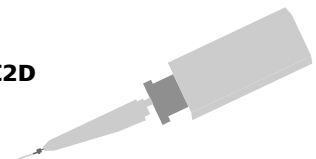

**EDS**



# ZEISS GeminiSEM: Your Flexible Choice of Components

- › In Brief
- › The Advantages
- › The Applications
- › **The System**
- › Technology and Details
- › Service

Selected Detectors	Offerings	ZEISS GeminiSEM 560	ZEISS GeminiSEM 460	ZEISS GeminiSEM 360
Inlens SE Detector (Inlens secondary electron)	Ultra-high resolution surface information	●	●	●
Inlens BsE Detector (Inlens energy selective backscatter)	Material contrast	○	○	○
Chamber SE Detector	Topographical information	●	●	●
C2D Detector	High efficiency and high sensitivity imaging in variable pressure modes	○	○	○
VPSE Detector	High efficiency imaging in variable pressure modes	○	○	○
AsB Detector (angular selective backscatter)	Compositional and crystallographic contrasts, 3D surface modeling	–	○	○
aBSD Detector	5 or 6 segment backscattered electron detector with up to 4 parallel channels for compositional and crystalline surface analysis, 3D surface modeling	○	○	○
aSTEM Detector (annular STEM)	7 segments transmission electron detection for high resolution transmission imaging	○	○	○
YAG Detector	YAG crystal scintillator BSE detector compositional imaging	○	○	○
SCD Detector	Specimen current detector for imaging electron absorbed current in the specimen	○	○	○
EDS Detector (energy dispersive spectroscopy)	Elemental analysis	○	○	○
EBSD Detector (electron backscatter diffraction)	Investigation of crystalline orientation	○	○	○
CL Detector	Material characterization by cathodoluminescence	○	○	○
WDS Detector (wavelength dispersive spectroscopy)	High energy resolution elemental analysis	○	○	○

● included ○ optional – not available

# ZEISS GeminiSEM: Your Flexible Choice of Components

- › In Brief
- › The Advantages
- › The Applications
- › **The System**
- › Technology and Details
- › Service

Accessories	Offerings	ZEISS GeminiSEM 560	ZEISS GeminiSEM 460	ZEISS GeminiSEM 360
<b>3D STEM Tomography</b>	Electron tomography for nanoscale 3D visualization	○	○	○
<b>80 mm Airlock</b>	Sample transfer in less than 45 seconds	○	○	○
<b>Plasma Cleaner</b>	Gentle removal of sample contamination	○	○	○
<b>Standard VP</b>	StandardVP, variable pressure vacuum up to 60 Pa to reduce charging effect of non-conductive samples	○	○	○
<b>NanoVP</b>	Variable Pressure vacuum up to 500 Pa to reduce charging effect of non-conductive samples	○	○	○
<b>Local Charge Compensation</b>	Local gas injection to reduce charging effect of non-conductive samples	○	○	○
<b>Local Charge Compensation and <i>In situ</i> Oxygen Cleaning</b>	<i>In situ</i> cleaning of sample surface, reducing charging effect of non-conductive samples	○	○	○
<b>Tandem decel</b>	Beam deceleration of up to 5 kV for resolution and contrast enhancement at low landing energies	○	○	○
<b>Atlas 5</b>	Solution for automated image acquisition, data correlation and multi-modal 2D and 3D workflows	○	○	○
<b>Software</b>				
<b>ZEN Connect</b>	Module to organize and align image data in a correlative workspace	○	○	○
<b>ZEN Connect 2D Add on</b>	Module for an automated correlative 2D workflow that overlays data of light microscopes and SEMs	○	○	○
<b>ZEN Automated Imaging</b>	SEM image acquisition within the workspace of ZEN Connect to set up regions using predefined protocols	–	○	–
<b>ZEN Intellesis</b>	Module for machine learning based image segmentation	○	○	○
<b>ZEN Data Storage</b>	Central database accessible from any microscope or analysis workstation	○	○	○
<b>3DSM (3 dimensional surface modeling)</b>	Module for real time three dimensional surface modeling	○	○	○

● included ○ optional – not available

# Technical Specifications

- › In Brief
- › The Advantages
- › The Applications
- › The System
- › **Technology and Details**
- › Service

Essential Specifications	ZEISS GeminiSEM 560	ZEISS GeminiSEM 460	ZEISS GeminiSEM 360
<b>Resolution*</b>	0.4 nm @ 30 kV (STEM)	0.6 nm @ 30 kV (STEM)	0.6 nm @ 30 kV (STEM)
	0.5 nm @ 15 kV	0.7 nm @ 15 kV	0.7 nm @ 15 kV
	0.7 nm @ 1 kV TD	1.0 nm @ 1 kV / 500 V TD	1.0 nm @ 1 kV TD
	0.8 nm @ 1 kV	1.1 nm @ 1 kV / 500 V	1.2 nm @ 1 kV
	1.0 nm @ 500 V	1.5 nm @ 200 V	–
<b>Analytical Resolution</b>	–	2.0 nm @ 15 kV, 5 nA, WD 8.5 mm	–
<b>Inlens BSE Resolution</b>	1.0 nm @ 1 kV	1.2 nm @ 1 kV	1.2 nm @ 1 kV
<b>Resolution in NanoVP mode (30 Pa)</b>	1.4 nm @ 3 kV	1.4 nm @ 3 kV	1.4 nm @ 3 kV
	1.0 nm @ 15 kV	1.0 nm @ 15 kV	1.0 nm @ 15 kV
<b>Acceleration Voltage</b>		0.02 - 30 kV	
<b>Probe Current</b>	3 pA - 20 nA (100 nA configuration also available)	3 pA - 40 nA (100 nA or 300 nA configuration also available)	3 pA - 20 nA (100 nA configuration also available)
<b>Maximum field of view in high resolution mode</b>	1.6 mm at 1 kV and WD = 7 mm	5 mm at 5 kV and WD = 8.5 mm	5 mm at 5 kV and WD = 8.5 mm
<b>Maximum field of view in overview mode</b>	5.6 mm at 15 kV and WD = 8.5 m		
	130 mm at max. WD (ca. 50 mm)		
<b>Magnification</b>	1 – 2,000,000	8 – 2,000,000	8 – 2,000,000

\* Upon final installation, the resolution is proven in the systems acceptance test at 1 kV and 15 kV in high vacuum

# Technical Specifications

- › In Brief
- › The Advantages
- › The Applications
- › The System
- › **Technology and Details**
- › Service

Essential Specifications	ZEISS GeminiSEM 560	ZEISS GeminiSEM 460	ZEISS GeminiSEM 360
Electron Emitter		Thermal field emission type, stability better than 0.2 %/h	
Detectors available with basic configuration		Inlens Secondary Electron detector	
		Everhart Thornley Secondary Electron detector	
Selected Optional Detectors		High efficiency VPSE detector	
		Cascade current detector (C2D)	
		Annular solid state backscattered detector (aBSD)	
	–	Angular selective backscattered detector (AsB4)	
		Annular STEM detector (aSTEM4)	
Store Resolution		Up to 32k × 24k pixels	
Specimen Stage		5-axes motorized eucentric specimen stage	
		X = 130 mm; Y = 130 mm	
		Z = 50 mm	
		T = -4° to 70°	
		R = 360° (continuous)	
		Specimen size: up to 179 mm in diameter for the full stage travel range of 130 mm. Additional stage options available on request	

# Count on Service in the True Sense of the Word

- › In Brief
- › The Advantages
- › The Applications
- › The System
- › Technology and Details
- › **Service**

Because the ZEISS microscope system is one of your most important tools, we make sure it is always ready to perform. What's more, we'll see to it that you are employing all the options that get the best from your microscope. You can choose from a range of service products, each delivered by highly qualified ZEISS specialists who will support you long beyond the purchase of your system. Our aim is to enable you to experience those special moments that inspire your work.

## **Repair. Maintain. Optimize.**

Attain maximum uptime with your microscope. A ZEISS Protect Service Agreement lets you budget for operating costs, all the while reducing costly downtime and achieving the best results through the improved performance of your system. Choose from service agreements designed to give you a range of options and control levels. We'll work with you to select the service program that addresses your system needs and usage requirements, in line with your organization's standard practices.

Our service on-demand also brings you distinct advantages. ZEISS service staff will analyze issues at hand and resolve them – whether using remote maintenance software or working on site.

## **Enhance Your Microscope System.**

Your ZEISS microscope system is designed for a variety of updates: open interfaces allow you to maintain a high technological level at all times. As a result you'll work more efficiently now, while extending the productive lifetime of your microscope as new update possibilities come on stream.



*Profit from the optimized performance of your microscope system with services from ZEISS – now and for years to come.*

>> [www.zeiss.com/microservice](http://www.zeiss.com/microservice)



**Carl Zeiss Microscopy GmbH**  
07745 Jena, Germany  
microscopy@zeiss.com  
www.zeiss.com/geminisem